



Owner's Manual

5th Controller

V1.3_150731



Copyright Statement

GD Han's Yueming Laser Group co.,Ltd.

All rights reserved.

GD Han's Yueming Laser Group co.,Ltd (Han's Yueming Laser hereafter) reserves the right to modify the products and product specifications described in this manual without advance notice.

Han's Yueming Laser is not responsible to any direct, indirect, or consequential damage or liability caused by improper use of this manual or the product.

Han's Yueming Laser owns the patent, copyright or any other intellectual property right of this product and the related software. No one shall duplicate, reproduce, process or use this product and its parts, unless authorized by Han's Yueming Laser.

All the name referred in this manual only for identification, if belongs to other company's registered trademark or copyright, proprietary rights of the name belongs to their respective holder.





Foreword

Thanks for purchasing the laser engraving machine control system of our company.

Before operating, please read this manual carefully to ensure proper operation.

Please keep the manual properly for reference.

Since the configuration are different, certain models do not have the functions listed in this manual. Please refer to the specific functions for details.

Due to the constantly tech update, the specification for reference only, subject to the real standard.

Tags in this book :

 Alarm	Special Attention: User must follow and perform as the manual, otherwise, it could lead to errors or relatively serious problem.
---	--

 Note	Note: User should comply with the attention and suggestion in this manual; it could bring much easier operation.
--	--





Contents

Copyright Statement	II
Foreword	III
Contents	II
Chapter1 Software Introduction.....	1
1.1 System Function	1
Chapter2 System Installation.....	2
2.1 System Installation and uninstallation	2
2.1.1 Installation Requirements.....	2
2.1.2 SmartCarve4 Installation.....	2
2.1.3 SmartCarve4 uninstallation.....	4
2.2 Driver Installation and uninstallation	6
2.2.1 Driver Installation.....	6
2.2.1.1 Installing Drivers under Windows XP	6
2.2.1.2 Installing Drivers under Windows 7.....	11
2.2.2 Uninstalling Drivers.....	18
2.2.2.1 Uninstalling Drivers under Windows XP.....	18
2.2.2.2 Uninstalling Drivers under Windows 7	20
Chapter3 System Application.....	22
3.1 Software Interface	22
3.2 Flow	23
3.2.1 Data Process Flow	23
3.3 Machine Setting.....	23
3.4 Control panel and Data process	24
3.4.1 Layer Parameter.....	24
3.4.2 Process	28
3.4.3 Test.....	30
3.4.4 Document.....	31
3.4.5 Information	34





- 3.4.6 Data Process.....35
- Chapter4 Pictures and Interfaces38
 - 4.1 Object Pictures of MainBoard38
 - 4.2 Object Pictures of Panel38
- Chapter5 Operating Instruction of Panel.....39
 - 5.1 Introduction to the Panel and Keys39
 - 5.1.1 The whole panel.....39
 - 5.1.2 Introduction to the Keys39
 - 5.2 Introduction to the Main Interface40
 - 5.2.1 The main interface40
 - 5.2.2 Speed key41
 - 5.2.3 Max/Min power keys41
 - 5.2.4 Set the layer parameters.....42
 - 5.3 Z/U Key42
 - 5.3.1 Z move.....43
 - 5.3.2 U move43
 - 5.3.3 Axis reset+43
 - 5.3.4 Cur file entity+44
 - 5.3.5 Manual set+44
 - 5.3.6 Laser set+44
 - 5.3.7 Origin set+45
 - 5.3.8 Set Fact Para.....46
 - 5.3.9 Def Fact Para46
 - 5.3.10 Auto Focus.....47
 - 5.3.11 Language47
 - 5.3.12 IP Setup47
 - 5.3.13 Diagnoses47
 - 5.3.14 Screen Origin.....48
 - 5.3.15 Extend setup+49
 - 5.4 File Key.....49





5.4.1	Memory File	49
5.4.2	U Disk File.....	53
5.5	Introduction to some alarm info	53
Chapter6	Manufacturer/User Parameters Explanation	55
6.1	Manufacturer parameters	55
6.2	User parameters	57
6.3	How to set the parameter of the electronic double head mode	60
Chapter7	Applications.....	63
7.1	The method to connect mainboard.....	63
7.2	Machine Parameters Setting	64
7.3	How to set the home parameters	64
7.4	Breath	65
7.5	External parameters	66
7.6	Coordinates.....	66
7.6.1	Machine coordinates	66
7.6.2	Relative coordinates	67
7.7	Normal processing.....	68
7.7.1	Vector graphics processing	68
7.7.2	Bitmap processing.....	69
7.8	Application of specific functions.....	71
7.8.1	Array function	71
7.8.2	About the leftover graphics outputting	72
7.8.3	Output graphics within the workspace range.....	73
7.8.4	Ultra-range graphics processing	74
7.8.4.1	Setting parameters	74
7.8.4.1.1	Compensation setting	77
7.8.4.2	Ultra-range non array graphics processing.....	77
7.8.4.3	Ultra-range array graphics processing.....	79
7.8.5	The operation of double-head laser machine.....	79
7.8.5.1	Setting parameters	79





7.8.5.2	Processing.....	80
7.8.6	The operation of exchange platform	80
7.8.6.1	Setting parameters	80
7.8.6.2	Processing.....	82
7.8.7	Auto focus	82
7.8.8	The operation of the rotary engraving	83
7.8.8.1	Setting parameters	83
7.8.8.2	Processing.....	85
7.8.9	Graphic counting mode.....	85
7.8.9.1	Changes in interface	85
7.8.9.2	Function configuration and limitations	86
7.8.9.3	Process counting method.....	88
7.8.9.4	Output process data to the board.....	88
7.8.10	Pen function	91
7.8.11	History record	93
Post	95





Chapter1 Software Introduction

The 5th controller card is controlled by SmartCarve4.3 which the software is development by Han's yueming laser. If user want to acknowledge the operation of SmartCarve4.3, user can reference the manual of "Software Manual for Smartcarve4 Series" which is released by our company.

1.1 System Function

◆ Peripheral interface

The controller support both USB transmission and Cable transmission.

◆ Motion control function

Motion control module includes a manual shift, laser burst, back to zero, cut scale, automatic process control and process information display function, not only for motor motion control achieved through the control panel, but also through software.

◆ Graphics

The software has a simple graphical rendering capabilities, including point, line, circle (arc), rectangles, polygons, Bezier curves, text, and other basic drawing primitives. Also has a vector or bitmap import, support plt(HPGL/HPGL2), dxf, ai, dst, dsb, nc, out, oux, ymd, yln, bmp, jpg graphic files into other formats. Can the graphics layout, zoom, pan, mirror, rotate, and node editing operation, user-friendly graphics drawing processing.

◆ Calculate the time

For normal control board, in order to draw a graph of the time until the graphic processing after processing can, and the 5th controller can not board before processing the graphics, the graphics to be processed by the download control board, the control board in advance by the calculated time required for the processing, user control of time. Not only this, the control board can also record a total boot time, total processing time, the previous processing time, total light time, total processing times and X, Y-axis the cumulative stroke and other information.



Chapter2 System Installation

2.1 System Installation and uninstallation

2.1.1 Installation Requirements

Operating system: Windows 2000/XP/vista/win7 (32bits or 64bits)

PC:

CPU: >1GHz

Memory: > 1GB

2.1.2 SmartCarve4 Installation

- 1) Insert the soft CD into CD-ROM (or hard drive), find the SmartCarveInstall4.X.XX.exe and double click it, and then the following dialogue box will show up:



Fig. 2-1

Select your language, then click "OK":

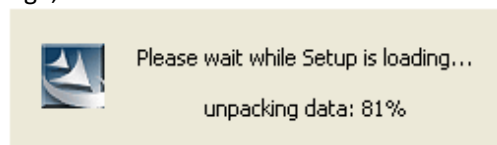

Fig. 2-2

- 2) Please wait till the system enters the following welcome interface:



Fig. 2-3



- 3) Click “Next”, enter the license page:

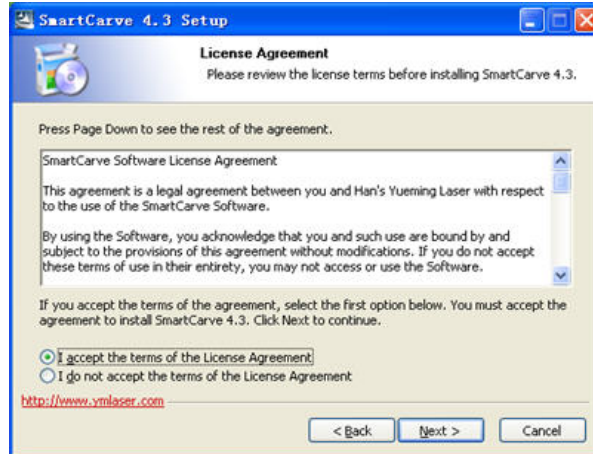

Fig. 2-4

- 4) Please read the software license agreement, if you need install the software ,select “I accept the terms in the license agreement”, and click “Next”:

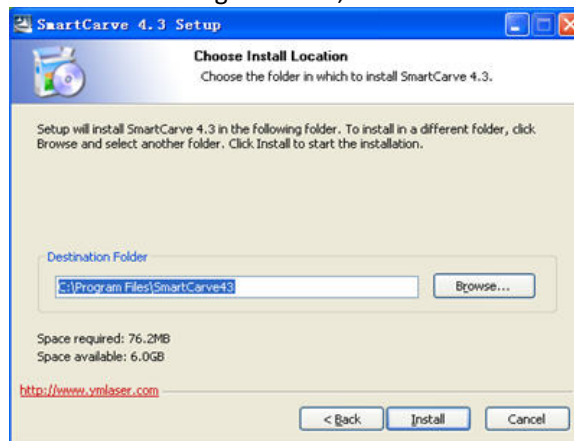

Fig. 2-5

- 5) Click “Browse” to locate the path of the target folder, and click “Install”:

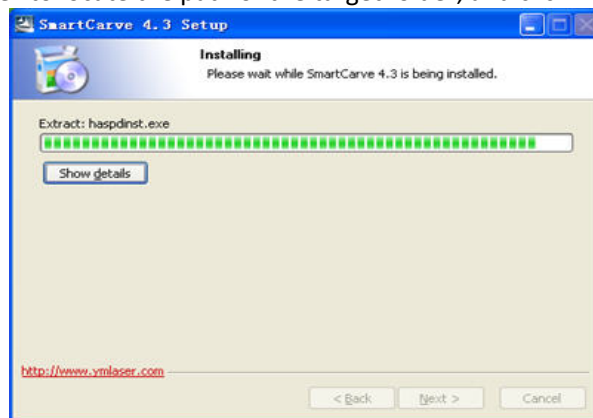

Fig. 2-6

- 6) Wait for the final prompt for completion:





Fig. 2-7

- 7) After the installation, a shortcut icon of SmartCarve4 will be displayed on the Windows desktop. Users can double click this icon for execution or select “Run SmartCarve4.3” upon completion of installation to run the software. And the following dialog box pops up:

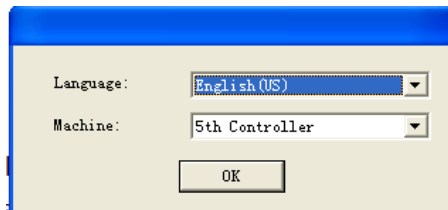

Fig. 2-8

Select the current language in the “Language” item, and select the “5th Controller” option in “Machine”. Then, click “OK” to start the software.

Softdog is required upon the initial use. If the soft can't check the correct softdog, user can't use this software, and the follow warm dialog will be shown:



Fig. 2-9



Note

Please keep your softdog well, if lose; please contact our company to buy another one.

2.1.3 SmartCarve4 uninstallation

- 1) Click “Start” → “All Programs” → “SmartCarve4.3” → “Uninstall”, the dialogue shows up:



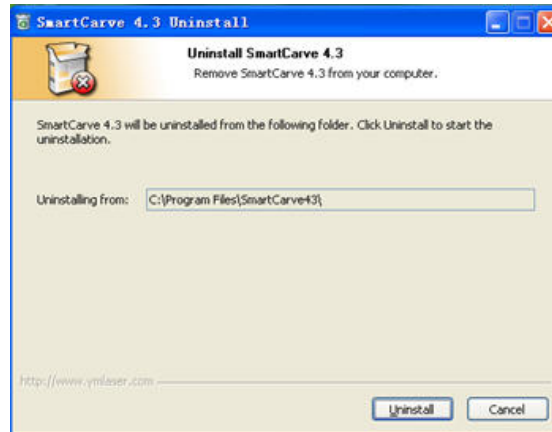

Fig. 2-10

- 2) Click “Next”, the following dialogue box will show up as soon as the progress bar completes:

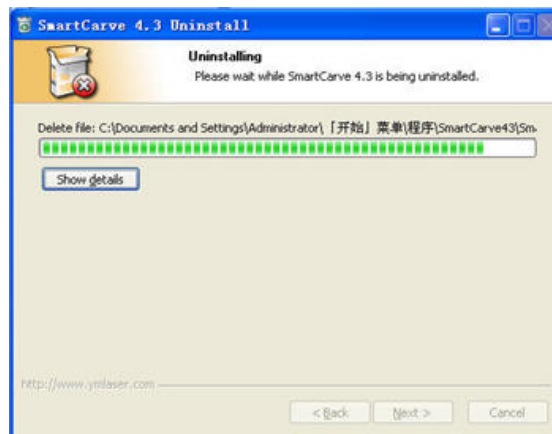

Fig. 2-11

- 3) Wait till the following dialogue box shows up upon completion:



Fig. 2-12

- 4) Click “Finish” to complete.





2.2 Driver Installation and uninstallation

2.2.1 Driver Installation

2.2.1.1 Installing Drivers under Windows XP

With a configuration of 5th controller Card, the laser engraving machine is linked to a PC via the USB port. Before using, driver should be installed properly. Drivers are in the folds of USB Virtual COM Port Drivers Bits32 and USB Virtual COM Port Drivers Bits64. You should install the proper driver according to the following table.

Table 2-1

Item	Description
USB Virtual COM Port Drivers Bits32	For 32-bit CPU
USB Virtual COM Port Drivers Bits64	For 64-bit CPU

To install USB drivers for 5th Controller Card under Windows XP, follow the instructions below:

- ◆ If a device of the same type has been installed on your machine before and the drivers that are about to be installed are different from those installed already, the original drivers need to be uninstalled.
- ◆ If you are running Windows XP or Windows XP SP 1, temporarily disconnect your PC from the Internet. This can be done by either removing the network cable from your PC or by disabling your network card by going to the "Control Panel\Network and Dial-Up Connections", right-clicking on the appropriate connection and selecting "Disable" from the menu. The connection can be re-enabled after the installation is complete. This is not necessary under Windows XP SP 2 if configured to ask before connecting to Windows Update. Windows XP SP 2 can have the settings for Windows Update changed through "Control Panel\System" then select the "Hardware" tab and click "Windows Update".
- ◆ Power on your device and connect the device to a spare USB port on your PC. The Microsoft composite device driver is automatically loaded in the background. Once the composite driver has been installed Windows Found New Hardware Wizard will launch. If there is no available Internet connection or Windows XP SP 2 is configured to ask before connecting to Windows Update, the screen shown in F2-13 is displayed. Select "No, not this time" from the options available and then click "Next" to proceed with the installation. If there is an available Internet connection, Windows XP will silently connect to the Windows Update website and install any suitable driver it finds for the device in preference to the driver manually selected.





Fig. 2-13

- ◆ Select "Install from a list or specific location (Advanced)" as shown in Fig.2-14 below and then click "Next".



Fig. 2-14

- ◆ Select "Search for the best driver in these locations" and enter the file path in the combo-box ("C:\USB Drivers\USB Virtual COM Port Drivers Bits32" in Fig.2-15 below) or browse to it by clicking the browse button. Once the file path has been entered in the box, click next to proceed.



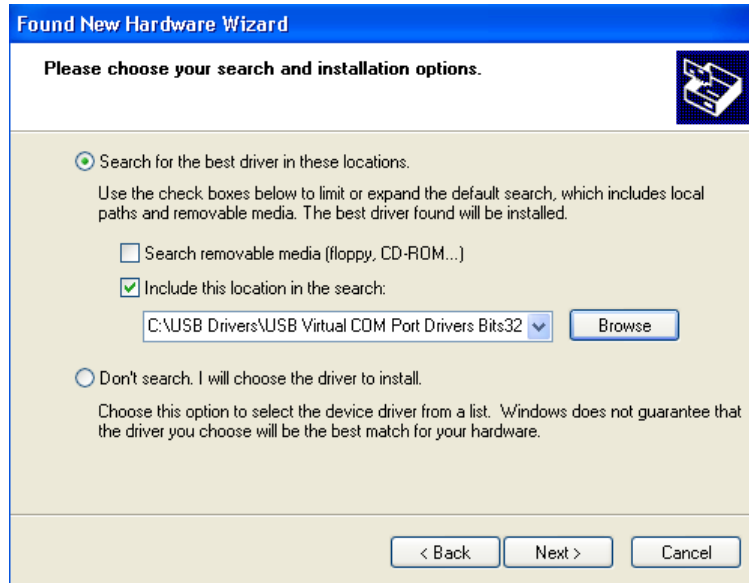

Fig. 2-15

- ◆ The screen shown in Fig.2-16 will be displayed as Windows XP copies the required driver files.



Fig. 2-16

- ◆ Windows should then display a message indicating that the installation was successful (Fig.2-17). Click "Finish" to complete the installation for the first port of the device.





Fig. 2-17

- ◆ The Found New Hardware Wizard will continue by installing the USB Serial Converter driver for the second port of the 5th Controller Card. The procedure for installing the second port is identical to that for installing the first port from the first screen of the Found New Hardware Wizard. This is done automatically if the driver is Microsoft WHQL certified.
- ◆ The Found New Hardware Wizard will launch automatically to install the COM port emulation drivers. As above, select "No, not this time" From the options and click "Next" to proceed with the installation (Fig.2-18).



Fig. 2-18

- ◆ Select "Install from a list or specific location (Advanced)" as shown in Fig.2-19 below and then click "Next".





Fig. 2-19

- ◆ Select "Search for the best driver in these locations" and enter the file path in the combo-box ("C:\USB Drivers\USB Virtual COM Port Drivers Bits32" in Fig.2-20 below) or browse to it by clicking the browse button. Once the file path has been entered in the box, click next to proceed.

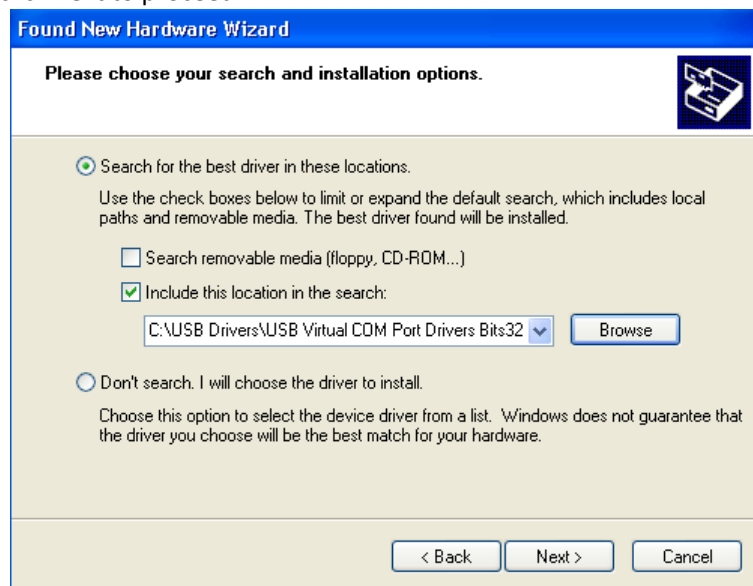

Fig. 2-20

- ◆ The screen shown in Fig.2-21 will be displayed as Windows XP copies the required driver files.





Fig. 2-21

- ◆ Windows should then display a message indicating that the installation was successful (Fig.2-22). Click "Finish" to complete the installation for the first port of the device.



Fig. 2-22

**Note**

View the USB port: Go to "Desktop" of Windows, select "My computer" and right click the mouse to select "Property", choose the "Hardware" option and click "Device manager". In the pop-up window, click "Port (COM and LPT)" to open it. If it shows "USB SERIAL PORT (COM3)", it means that the Linked port is the COM3.

2.2.1.2 Installing Drivers under Windows 7

To install USB drivers for 5th Controller Card under Windows 7, follow the instructions below:

- ◆ Power on your device and connect the device to a spare USB port on your PC.





- ◆ If a device of the same type has been installed on your machine before and the drivers that are about to be installed are different from those installed already, the original drivers need to be uninstalled.
- ◆ Press the Windows start button to bring up the start menu and select “Control Panel” (Fig.2-23).

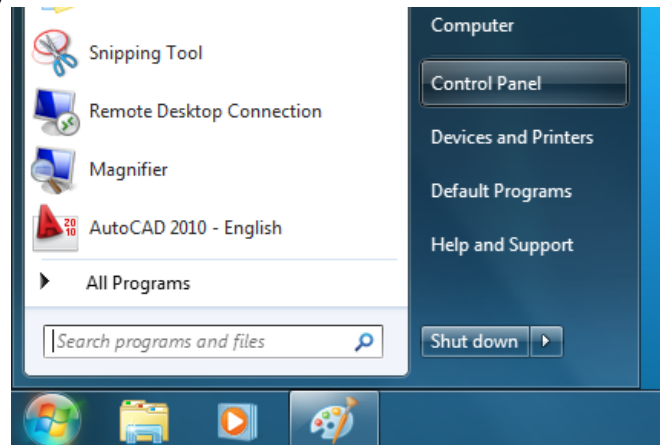

Fig. 2-23

- ◆ From the Control Panel window select Hardware and Sound

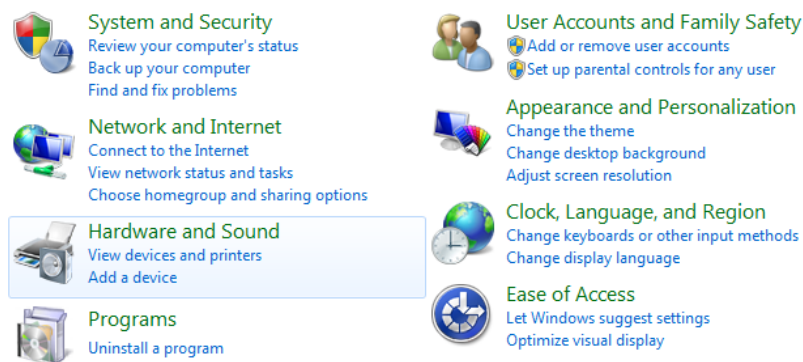

Fig. 2-24

- ◆ At the next screen select Device Manager:

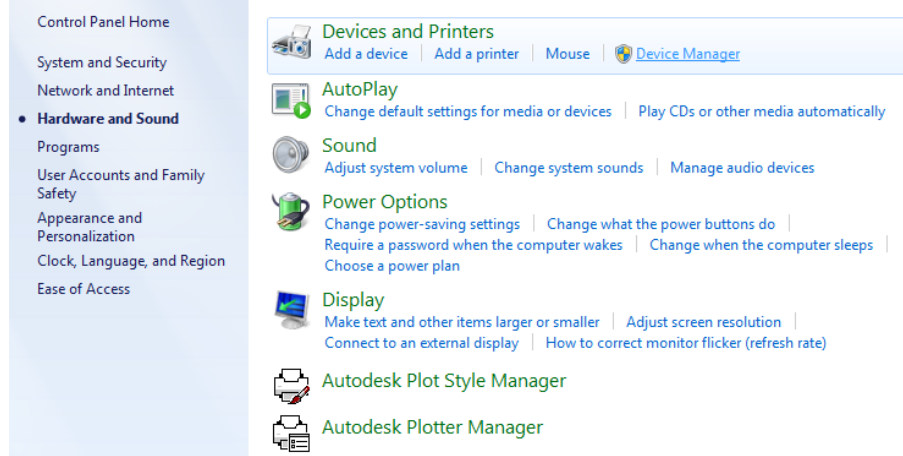

Fig. 2-25





- ◆ In the Device Manager window there will be a device under Other Devices with a yellow warning symbol to indicate a problem if no driver installed. The text next to this device will depend on the device attached. In this example the device was a VNC1L-A As Slave device. Right click on the VNC1L-A As Slave to bring up a menu as shown below. From the displayed menu select “Update Driver Software...”

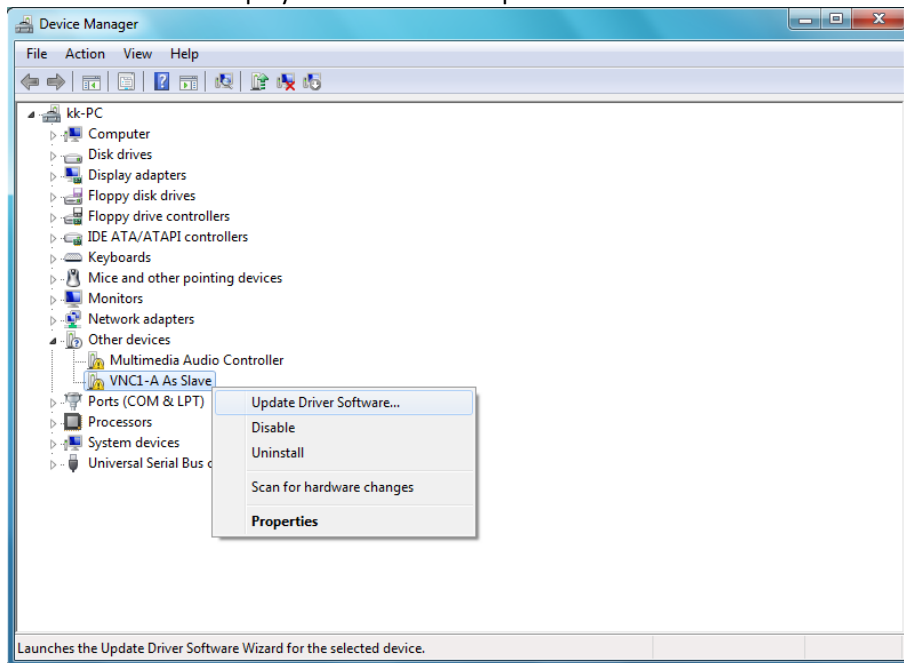

Fig. 2-26

- ◆ This then displays the option for an automatic search or a manual search. Select the second option to browse manually.

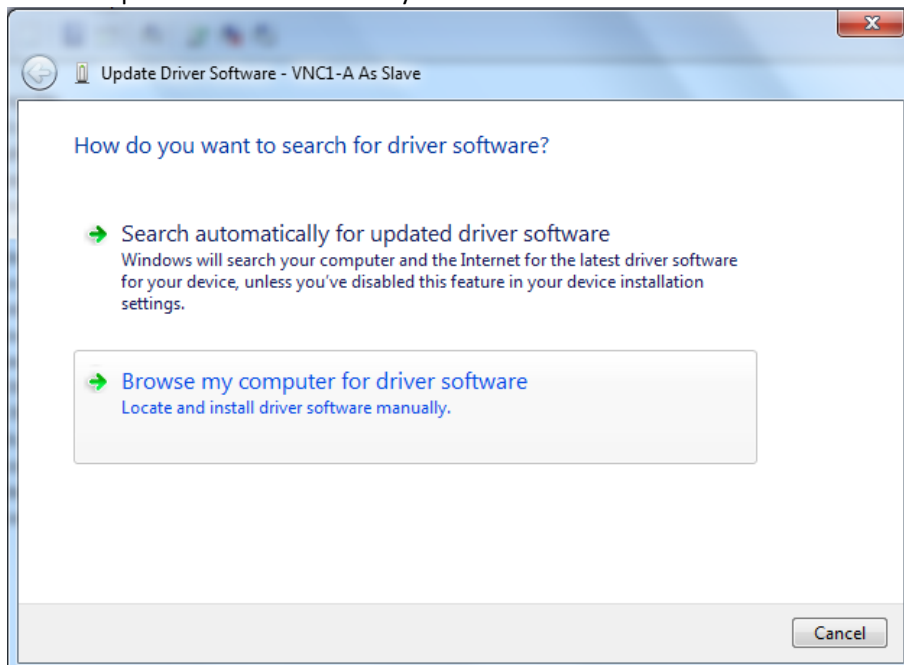

Fig. 2-27

- ◆ In the address box put the exact location where the drivers have been saved to. This may be on a CD or in a folder on the PC. It is not necessarily the exact same location as





shown in the screenshot. The drivers could have been saved anywhere of the users choosing. After entering the address select “NEXT” to start the installation.

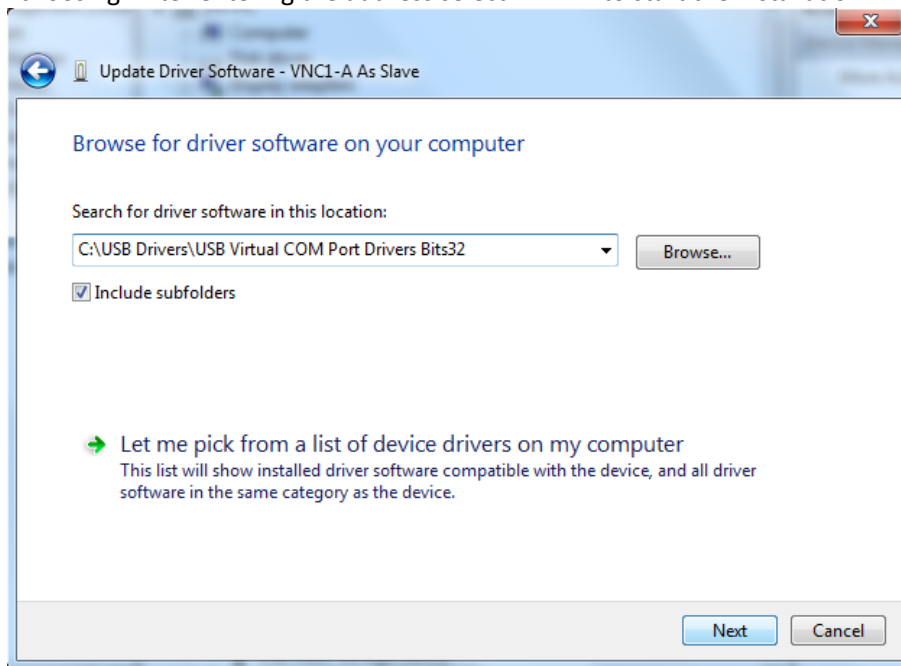

Fig. 2-28

- ◆ After entering the address select “NEXT” to start the installation.

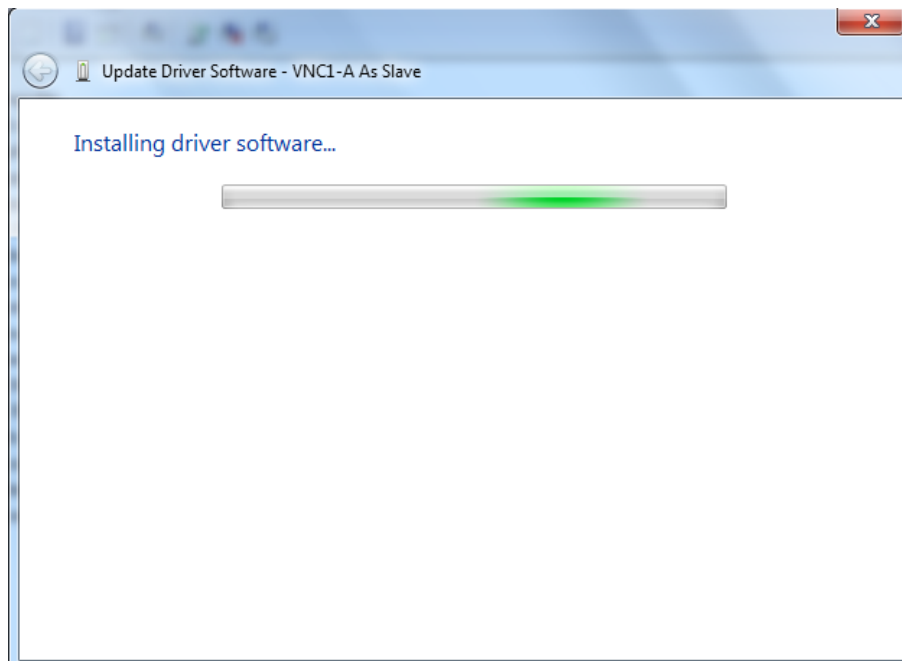

Fig. 2-29

- ◆ When the installation has finished a completion screen is displayed.



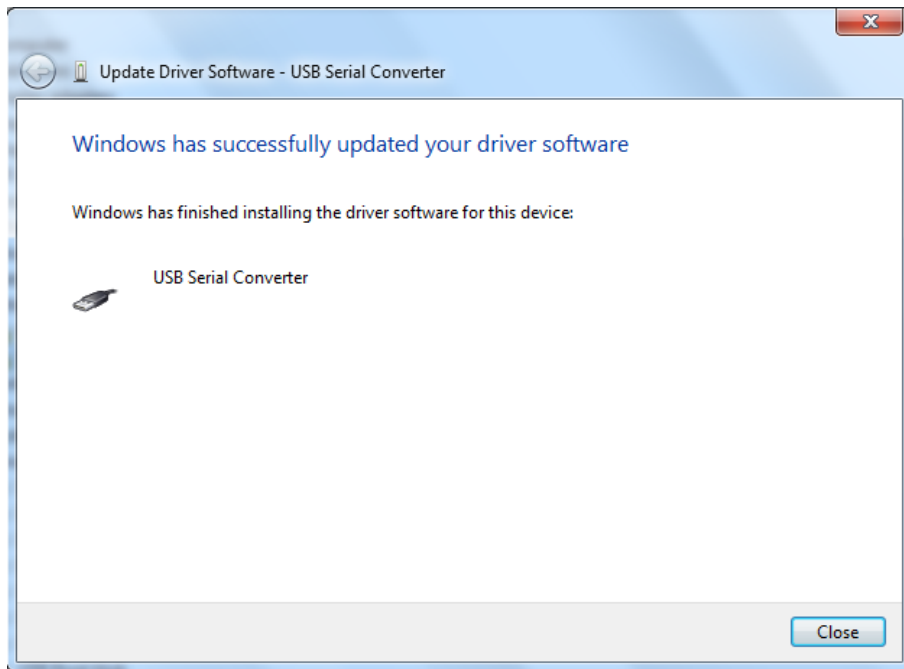

Fig. 2-30

- ◆ Go back to the Device Manager Window. The Device Manager will still show a device under Other Devices but in addition to this there is a new entry under Universal Serial Bus Controllers indicated in the screenshot above as the USB Serial Converter. This indicates the bus layer of the driver is installed. Installing the Virtual Com Port layer of the driver is almost a repeat of the last few steps. Right click on the other device (USB Serial Port in this example) to bring up a menu as shown below.

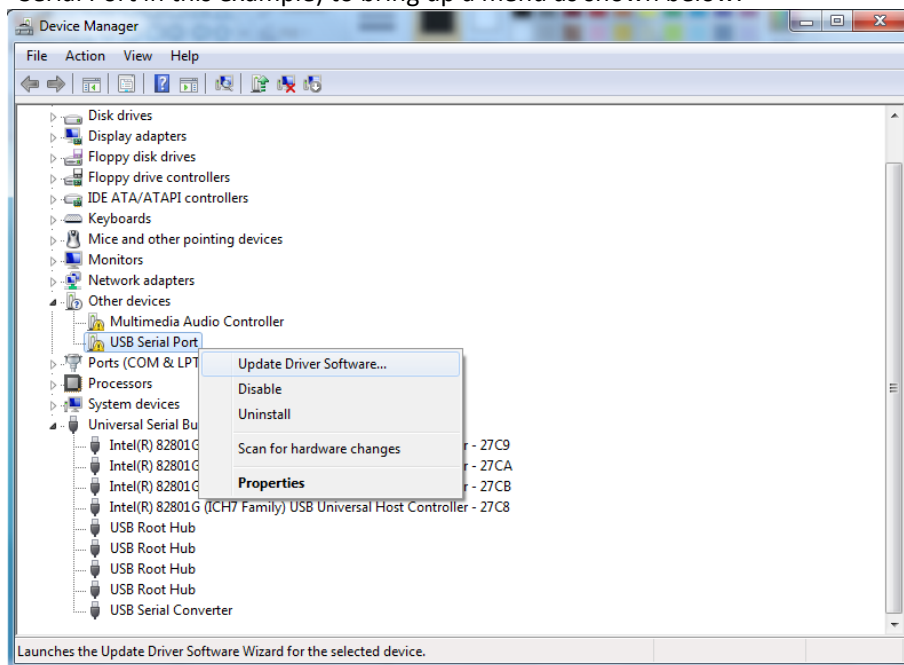

Fig. 2-31

- ◆ This then displays the option for an automatic search or a manual search. Select the second option to browse manually.



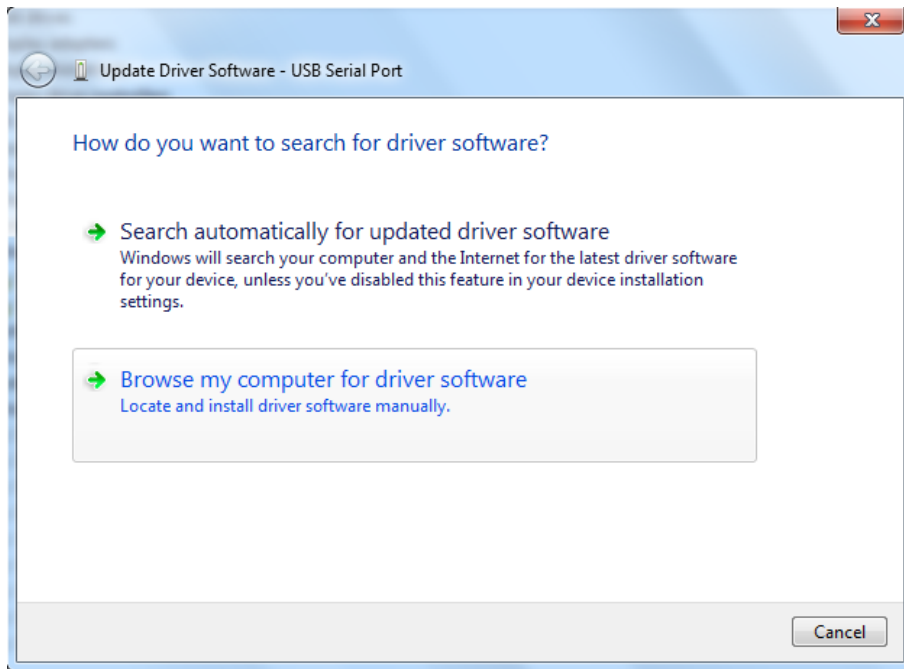

Fig. 2-32

- ◆ In the address box put the exact location where the drivers have been saved to. This may be on a CD or in a folder on the PC. It is not necessarily the exact same location as shown in the screenshot. The drivers could have been saved anywhere of the users choosing. After entering the address select “NEXT” to start the installation.

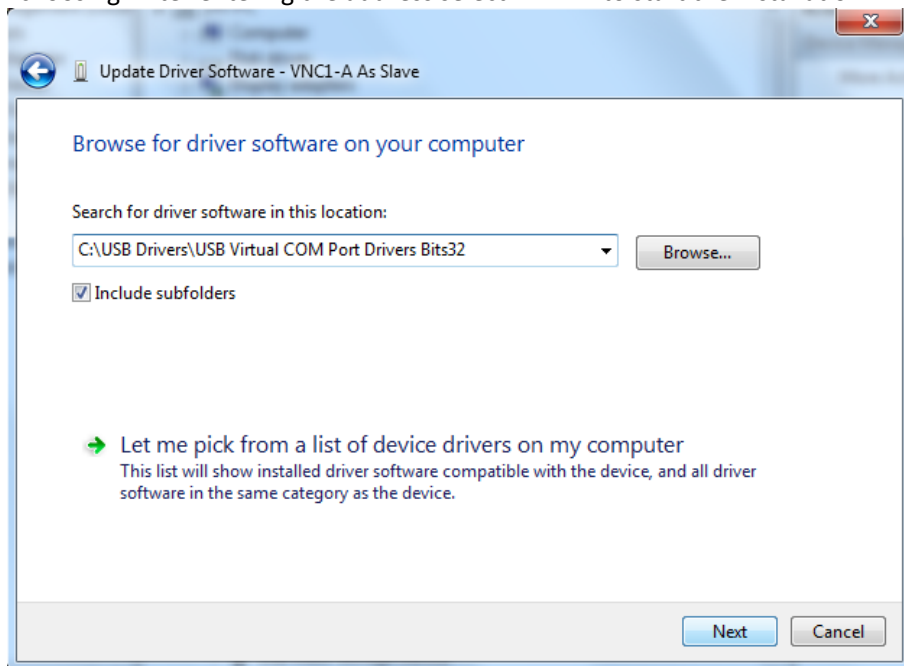

Fig. 2-33

- ◆ After entering the address select “NEXT” to start the installation.



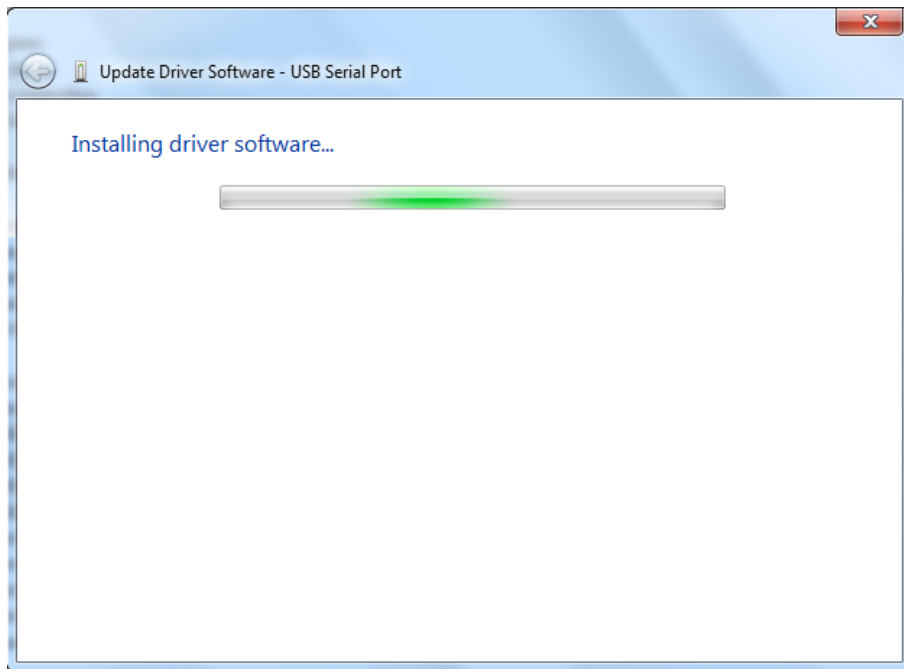

Fig. 2-34

- ◆ When the installation has finished a completion screen is displayed.

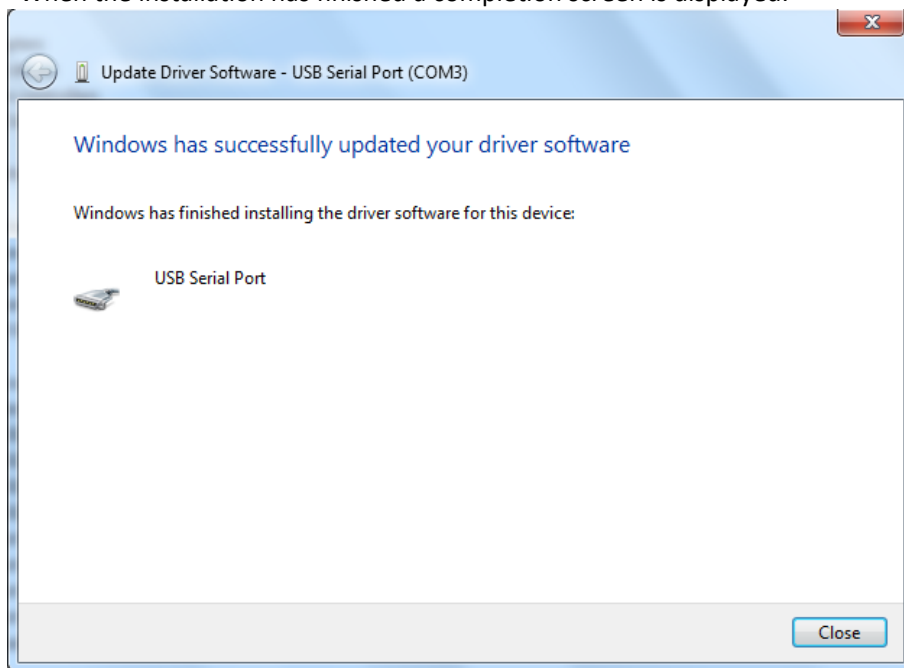

Fig. 2-35

- ◆ Note this screen also displays the COM port assigned to the device. Press Close to close this window and go back to the Device Manager Window. This time the Device Manager does not have a USB Serial Port entry under Other Devices but does show entries under Universal Serial Bus Controllers and Ports (COM & LPT). The above screen shot displays a correct installation. The device is now ready to use on COM3.



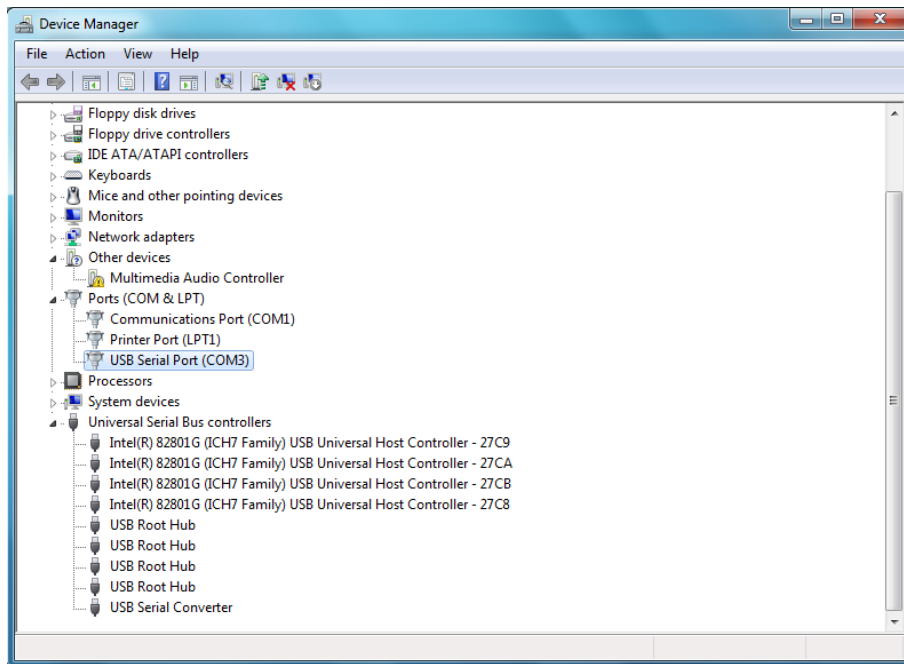

Fig. 2-36

2.2.2 Uninstalling Drivers

2.2.2.1 Uninstalling Drivers under Windows XP

To uninstall USB Driver for 5th Controller Card under Windows XP, an uninstaller program named CDMuninstallerGUI.exe is provided by us. Please follow the instructions below to uninstall the Drivers.

- ◆ Before uninstalling, Please disconnect the 5th Controller Card from the computer.
- ◆ Double click the CDMuninstallerGUI.exe (The uninstaller program and the USB drivers are in the disk which is provided by us. You can copy the program to anywhere in your computer. As shows in Fig.2-25, the path is C:\USB Drivers\USB Virtual COM Port Drivers Uninstaller_v1.4\CDMUninstaller_v1.4.

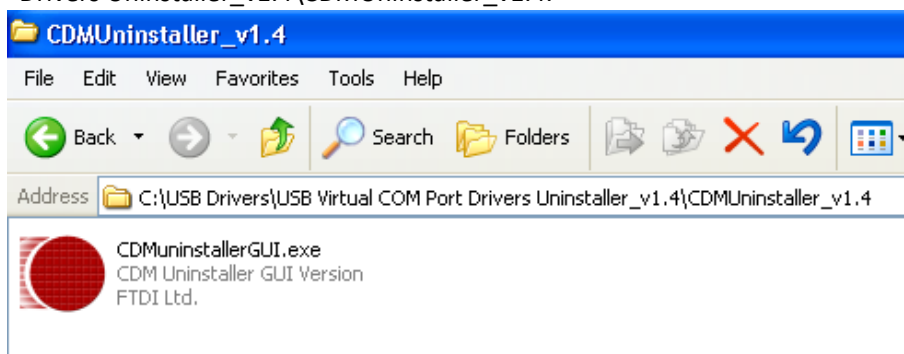

Fig. 2-37

- ◆ Double click the uninstaller program and a screen is displayed as below. By default, the vendor ID is set to 0403 and Produce ID is 6001.Click "Add" to add an item with Vendor ID is0403 and Product ID is 6001.

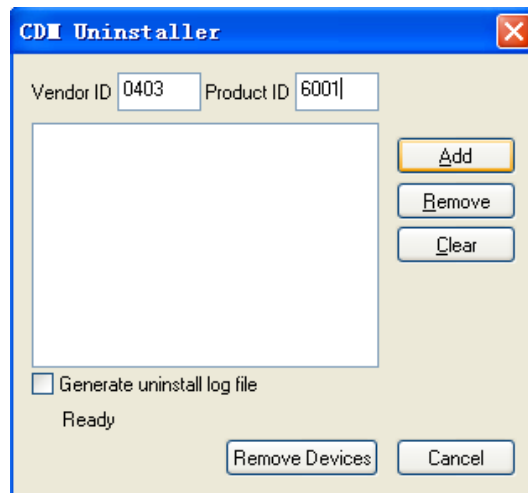

Fig. 2-38

- ◆ As the figure shows below , click “Removed Devices” to execute the uninstalling.

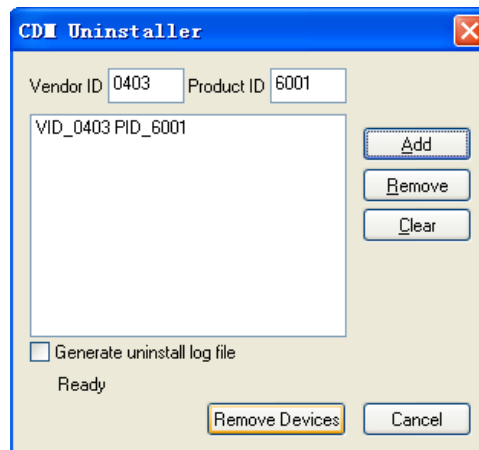

Fig. 2-39

- ◆ After removing the devices, a remove successful screen is displayed. Click ok to finish uninstalling.



Fig. 2-40

**Note**

There is another way for removing the device. Go to “Desktop” of Windows, select “My computer” and right click the mouse to select “Property”, choose the “Hardware” option and click “Device manager”. In the pop-up window, click “Port (COM and LPT)” to open it. It shows “**USB SERIAL PORT (exp. COM3)**”. The device can be removed by simply right-clicking on the device and selecting “Uninstall”. This will delete the associated registry entries for that device only. The same operation has to be done with the “**USB Serial Converter**” under the Universal Serial Bus Controllers in Device manager.



2.2.2.2 Uninstalling Drivers under Windows 7

- ◆ In the Device Manager window right click the USB Serial Port (for example: com3) to bring up a menu as shown below. From the displayed menu select “Uninstall”.

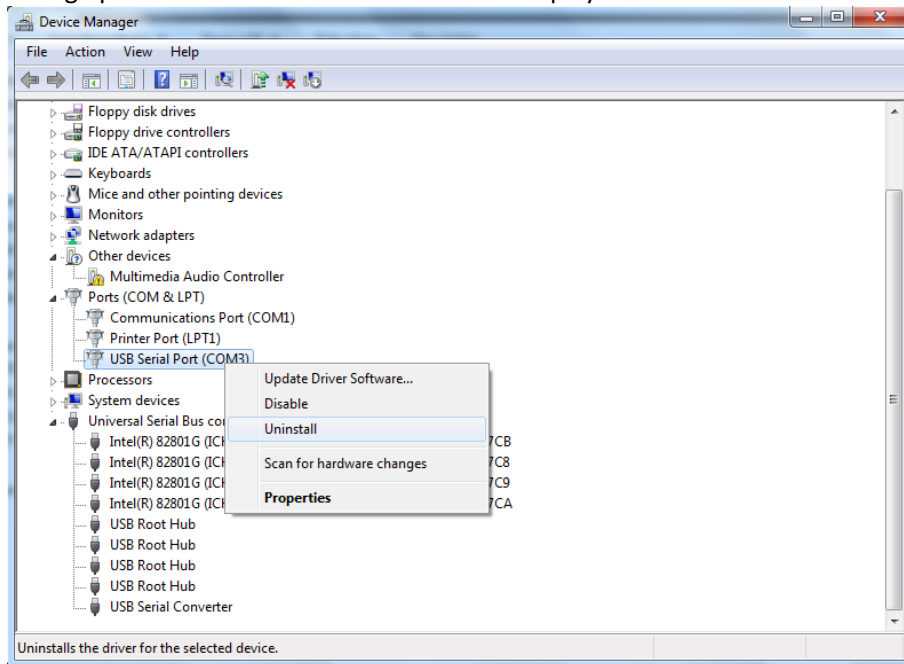

Fig. 2-41

- ◆ Click the check box to "Delete the driver software for this device" on the uninstall dialog box and select OK to uninstall the drivers.

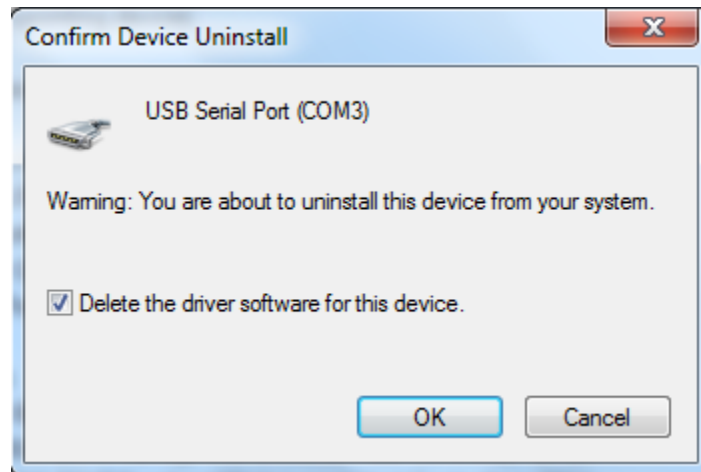

Fig. 2-42

- ◆ Go back to the Device Manager window. Right click the USB Serial Converter to bring up a menu as shown below. From the displayed menu select “Uninstall”.



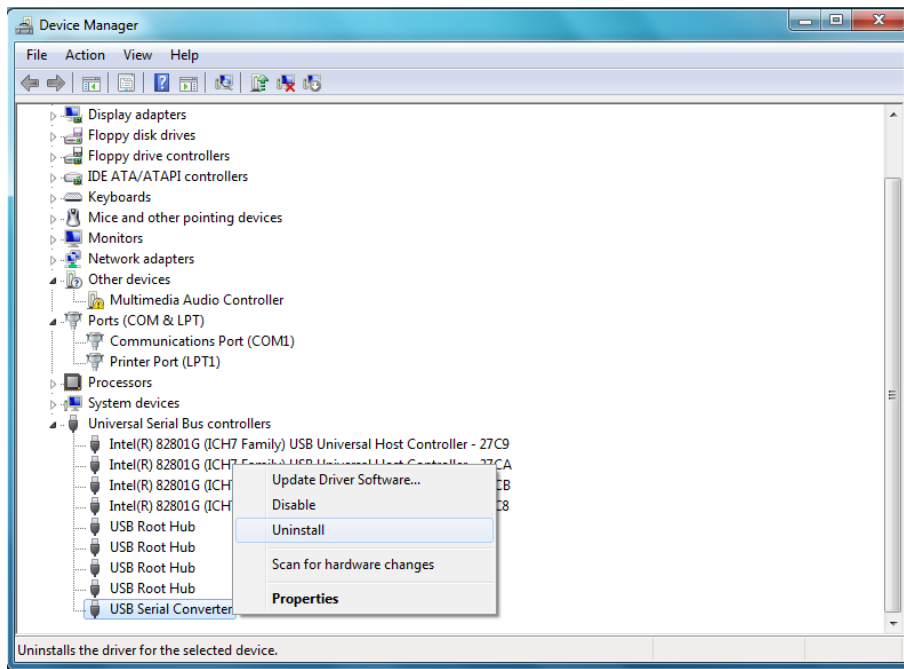

Fig. 2-43

- ◆ Click the check box to "Delete the driver software for this device" on the uninstall dialog box and select OK to uninstall the drivers.

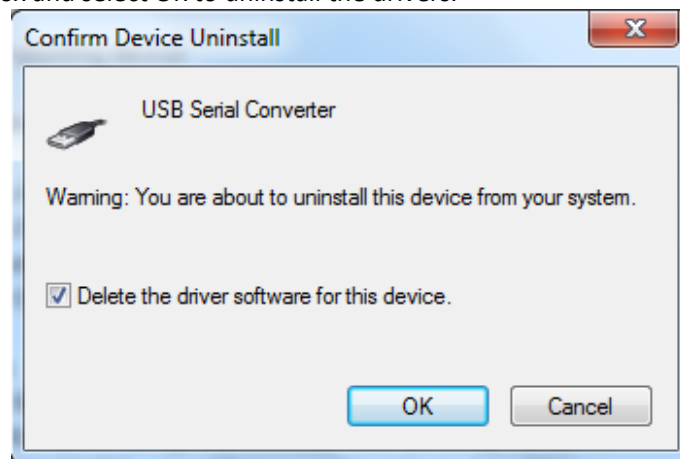

Fig. 2-44



Chapter3 System Application

3.1 Software Interface

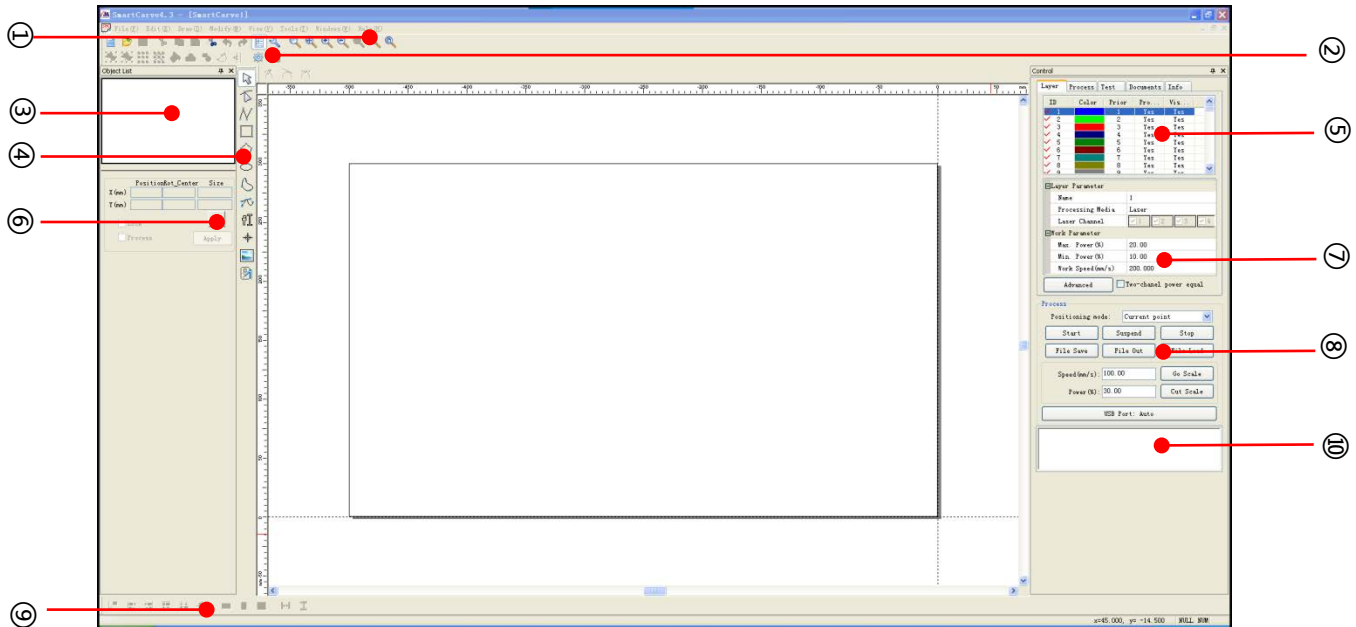

Fig 3-1

- ①System toolbar②Other toolbar③Graphic list④Draw toolbar⑤Layer list
⑥Graphic property⑦Layer parameter⑧Process ⑨Arrangement toolbar
⑩Information

System toolbar: there have some function key in the system toolbar, such as: New, Save, Modify, Redo/Undo, Zoom In/Out and so on.

Graphics list: Display the name and number of the graphics in the workspace.

Graphics property: Setting the property of graphics such as position, size and so on.

Draw toolbar: Draw the graphics such as line, rectangle, circle and so on, also support the import of vector and bitmap file format.

Layer list: Display the property of the layer. Such as the layer ID, color, priority, visible, process.

Layer parameter: Setting the parameter of the layer, and also the work parameter of the layer ID.

Arrangement toolbar: User can choose more than one graphics to make it arrangement according to the mode. Such as: left array, right array and so on.

Other toolbar: include the edit and modify function. Such as: Group, Ungroup, Array, Fill and so on.

Draw area: Display or Draw the graphics in the area.





3.2 Flow

3.2.1 Data Process Flow

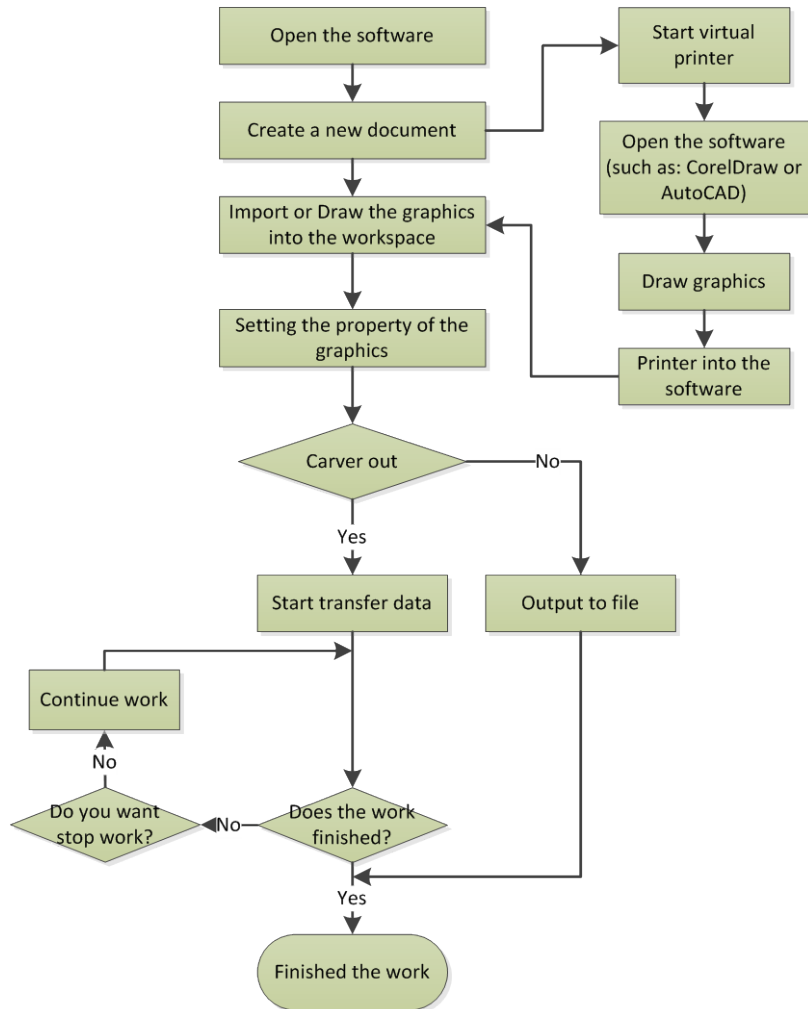

Fig 3-2

3.3 Machine Setting

For the detail of the parameter refers to the chapter 6.





3.4 Control panel and Data process

3.4.1 Layer Parameter

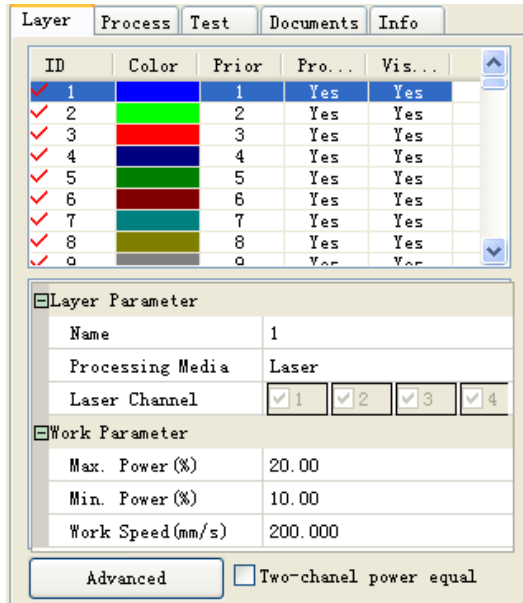

Fig 3-3

Layer can be taken as a kind of processing technology. A layer is equivalent to a processing technology. There are several kinds of processing parameters in a layer.

For example in a figure, some places need to be cut deeper and some places need to be cut shallower, this can be done easily with the help of layer settings.

As many as 256 layers are supported. Layer list, layer parameter and work parameter setting area are included.

➤ **Layer list**

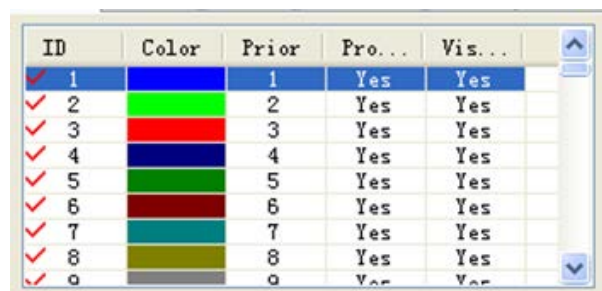

Fig 3-4

As many as 256 layers are supported. In the layer list, there are items like ID, Color, Priority, process, and visible.

In the layer list, the blue color indicates the checked layer, and the gray color indicates the current default layer. When drafting the figure, the figure is at the current default layer.

Color: Color of the layer, click this item to pop up dialogue box of color setting, user can choose any color to set it as the layer color:





Fig 3-5

Priority: Set the processing sequence of current layer from grade 1~256. Least grade is the highest priority, and grade 256 is the lowest priority.

Process: Set whether the figure data of the current layer is involved in the processing.

 Warm	<p>The relation between layer process and graph process:</p> <ul style="list-style-type: none"> ● When process of layer parameter setting “no”, no matter how to set the process of graph, all graphics of this layer are not processing. ● When process of layer parameter setting “yes”, if the process of graph setting “no”, the current graph will not process. <p>When process of layer parameter setting “yes”, if the process of graph setting “yes”, the current graph will process.</p>
----------	---

Visible: Set whether the figure data of the current layer is displayed in the drawing area
 Select a layer in the layer list and right click the mouse, a menu will pop up as follows:

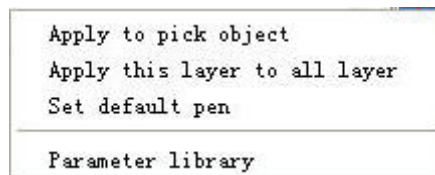

Fig 3-6

- ✧ **Apply to pick object:** after click this item, switch the layer number of selected object in the current drawing area to opposite layer ID number of current right click point.
- ✧ **Apply this layer to all layers:** after click this item, system will copy the layer parameters of current right click point to other layers.
- ✧ **Set default pen:** If this option is selected, all figures drafted in the drawing area belong to this layer.
- ✧ **Parameter library:** parameter library is used to save the current parameter which user set, please refer to next section:
- **Parameter library**



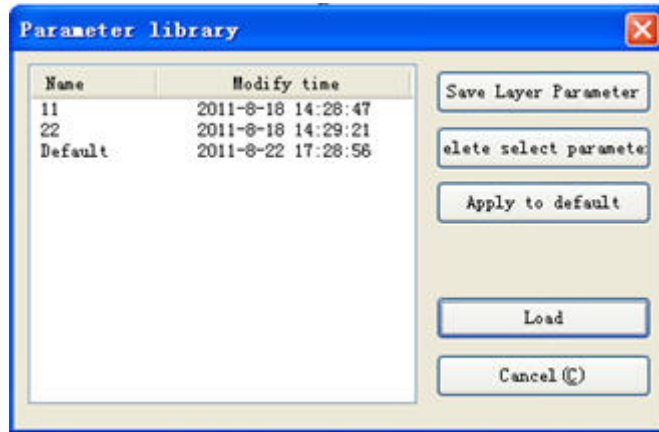

Fig 3-7

- ✧ **Save layer parameter:** save current process parameter to a new file, current layer parameter file can be changed.
- ✧ **Delete select parameter:** delete the selected parameter file of current list.
- ✧ **Apply to default:** revert the process parameter of current layer to default parameter (the primitive parameter)
- ✧ **Load:** click this button to load all the parameter of current selected file into process parameter of current layer. At this moment, "parameter name" will show current parameter file name.
- **Layer parameter**

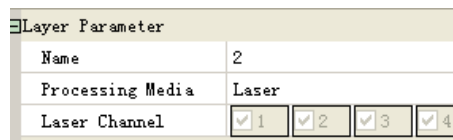

Fig 3-8

Layer name: Each layer has the exclusive number, cannot be modified.

Processing media: base on different users, the processing media can be selected. When choose laser to process, this parameter will be set "laser head". When choose pen to process, this parameter will be set "pen".

Laser channel:

When the machine have two or more, then user can adjust the different laser head position. Press "Tools" → "Config" → "Workspace" → "Multi Laser head"

➤ **Work parameter**

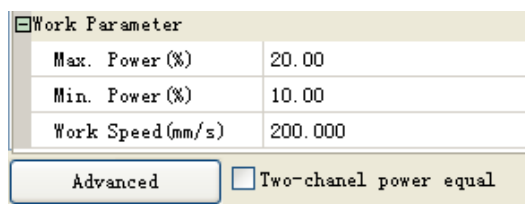

Fig 3-9

Work vel: Set the speed of single-axis motion when the machine is working



Min. power(%): The minimal value of laser when processing (0~100%)

Max. power (%): The maximum value of laser when processing (0~100%)

The maximum light intensity should always larger or equal to the minimal light intensity. In case of the similar speed, the larger the light intensity is, the deeper the engraving would be.

Two-channel power equal: if the option is chose, then the power of the two laser tube is the same, so the power can only set the laser head1. If the option is not chose, then the power of the two laser tube can be set separately.

➤ **Advance**

Press the “Advance” button to enter the parameter interface.

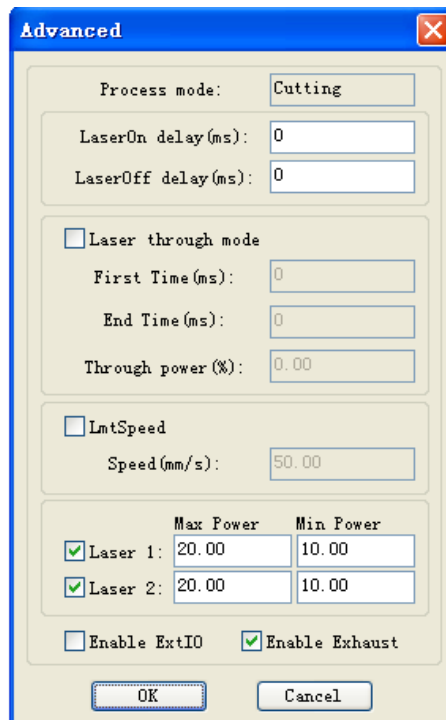

Fig 3-10

Process mode: there have two process mode: cutting and scan mode, if the graphics is the fill or bitmap, then the process mode is scan mode, otherwise, the scan mode is divide into four mode: H-two way scan, H-one way scan, V-two way scan, V-one way scan. This mode is according to the sweep mode of the bitmap or fills property.

The vector graphics is the cutting mode.

Laser On delay (ms): laser on delay when the working starts. Appropriate start delay can eliminate the phenomenon of “match head” when the working starts, but if the start delay is too long, the start section will lack strokes

Laser Off delay (ms): laser off delay when the workings end. Appropriate end delay can eliminate the phenomenon of unclosed when the working end, but if the end delay is too long, the end section will have the phenomenon of “match head”.

Open Delay: Medallion for a time / medallion latency

Close Delay: light off through wear / light off delay time





Laser through mode: If checked, the light switch delay said is on time, otherwise, the time delay switch is light delay said laser movement

Through power: Refers to crush objects in unit time of the work done fast.

Speed: if the LmtSpeed option is selected, the parameter is valid. This parameter is the max speed of the whole working.

Laser1、 2: if the “Two-channel power equal” option is selected, the power of the laser1 and laser2 is the same, but if the option is unselected, the power of the laser1 and laser2 can be set separately.

Enable Ext IO: if the option is selected, the extend IO can be used.

Enable exhaust: if the option is selected, the exhaust of the laser head is valid.

3.4.2 Process

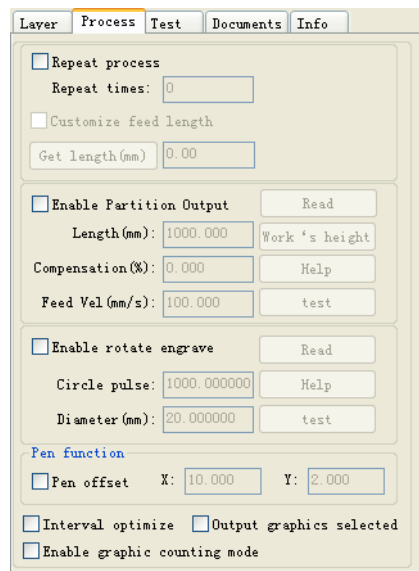

Fig 3-11

➤ Repeat

Repeat process: if the machine is have feeding, and then the option must be selected.

Repeat times: the numbers of the feeding.

Customize feed length: if this option is selected, the machine would feed the length as set. Otherwise the feed length is auto calculated by software.

➤ Partition

Enable Partition output: if the option is selected. The graphics is exceeding the work range of the machine, and then the software will split the graphics and splice the graphics.

Length (mm): The size to split the graphics. Generally, the size is the max size of the axis Y.

【work's height】 : To get the height of current workspace to be the **【Length】** .

Compensation:

【read】 : To read motherboard for getting current **【Compensation】** .





【Help】 To convert compensation ratio, shown below:

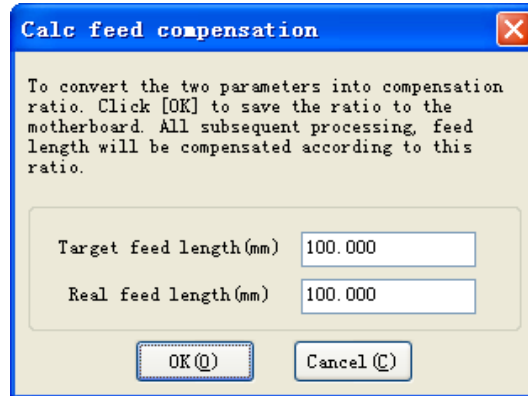

Fig 3-12

【Test】 Testing the moving distance is correct.

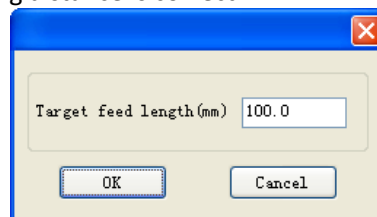

Fig 3-13

Enter the target feed length, click 【OK】 to move the feed axis. Measuring movement distance, if not correct, then use the help function to convert ratio and test again.

➤ **Rotate**

Enable rotate engrave: set this parameter to enable this function.

Circle pulse: number of pulse for turning the motor shaft one rotation.

Diameter: the work piece diameter.

Read: click this button to read “Circle pulse” from motherboard.

Test: it will send pulse as setting of circle pulse to turn the motor shaft. If it is not a circle turning, click the help button to set.

Help: click this button to show the dialog as below,

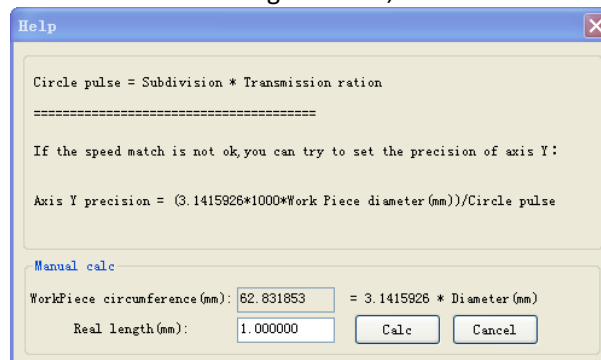



Fig 3-1





- **Interval optimize:** The function is used to the process of material similar to acrylic, which graphics are arranged closely. As a result, it can avoid hot distortion. But it will take more time than before.
- **Output graphics selected:** The function is used to output the graphics witch is selected in the draw area.
- **Enable graphic counting mode:** If this option is checked, then the mainboard can counting the entities of the cutting file, but if the array graphic is exceed the height of the workspace or user choose the “Enable partition output” option, then the mainboard cannot support the counting function. Please reference the [chapter7.8.9](#).
- **Pen function**
The function is used to control pen drawing by output IO. It will not output laser when processing, only pen draw.
- **Pen offset X/Y :** offset of pen refer to laser head.

 Tips	<p>Repeat work: set check the button 【Repeat process】 , then set the parameter 【feed length】 to be zero. As a result, the numbers of the 【Repeat times】 parameter is the numbers of repetitions. It will no feed.</p> <p>When it is work in mode of 【partition output】 or 【double-headed】, the workspace origin and the machine origin must be at the right down corner.</p>
---	---

3.4.3 Test

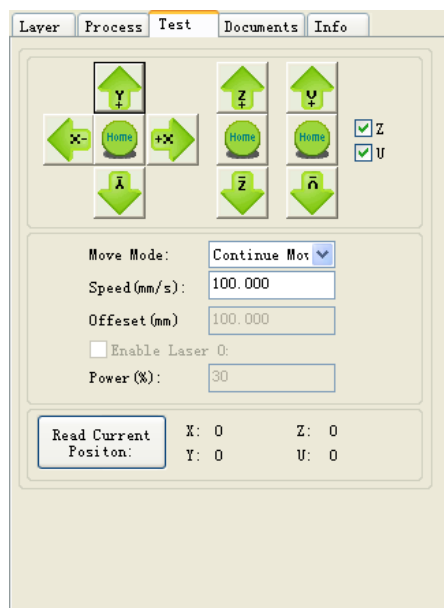

Fig 3-2

Axis control, can only control one axis each time. You can set the information for axis move, including move length、 speed、 laser on-off and laser power.

If you check “Move from origin”, then the offset you set means the offset to machine zero.

If you not check move from origin, then the offset means the offset to the current position.





The X-axis, for example, assuming the current position is 100mm, such as the step distance is set to 10mm, then the exercise once, the new location will be 110mm, such as the check moves from the origin, movement time, the new location will be 10mm, and repeated Movement, location will no longer change.

Note: According to the provisions of the controller, the absolute position is no negative in the whole breadth. If you check the Move From Origin, and set the offset value negative, then the machine will hit limiter.

3.4.4 Document

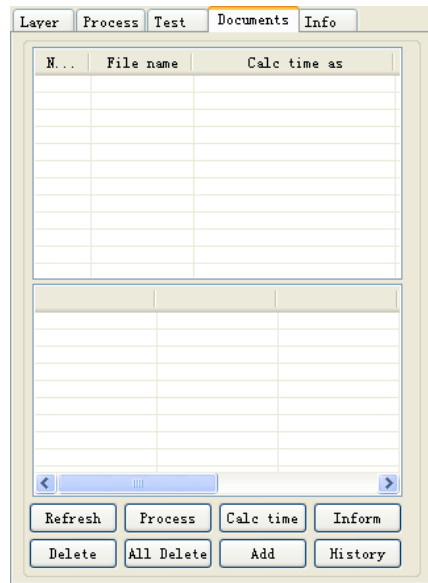

Fig 3-3

Refresh: Click button “Refresh”, the software will communications with the controller, read the list of files on the controller. After read controller successful ,file information will be displayed in the document list.

Process: Select the file to be processed from the document list ,and click button Process The controller will start the specified document.

Delete: Select the file you want to delete from the document list , and click button “Delete”, The controller will delete the specified document. If the deletion is successful , the document list will be updated.

All Delete: Automatically remove all file in the controller, and update the document list.

Calc time: Motherboard supports processing files towards hours worked. Select the file to calculate the work hours worked and click the button. Calculation to be completed, the control panel will be prompted to complete the calculation. And then point to read button shown in the list, calculated from the working hours.

In addition, when the document processing operation performed, the hours information will also be covered by the actual processing work.

Inform: User can press this button to inform the mainboard to beep 4 times.

Add: Click button Add, will pop up the file dialog , select “*.oud” downloaded file, then the file will be downloaded to the controller.



If the download is successful, the document list will update.

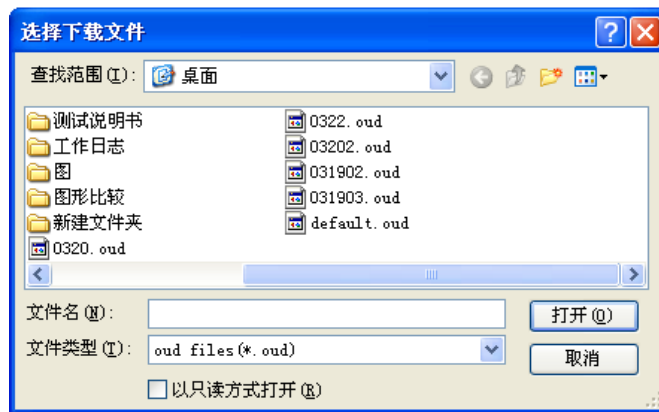

Fig 3-4 User can select more than one file to download into the mainboard

◆ **History** : click it to show dialog:

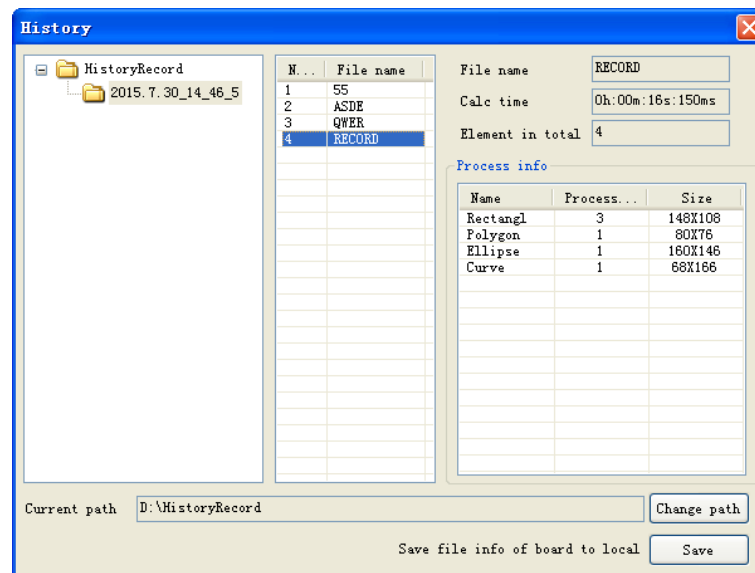

Fig 3-14

Change path: select the path of local to save file;

Save : Save files of board to local, including file name, graphics element, processed number, graphic size and so on, also processed time if it has been processed. A folder will be created automatically, and named by format “year.month.day_hour_minute_second”.

Right click mouse function: right click mouse on the folder list or the file list to select function that “Delete selected” and “Delete all”.

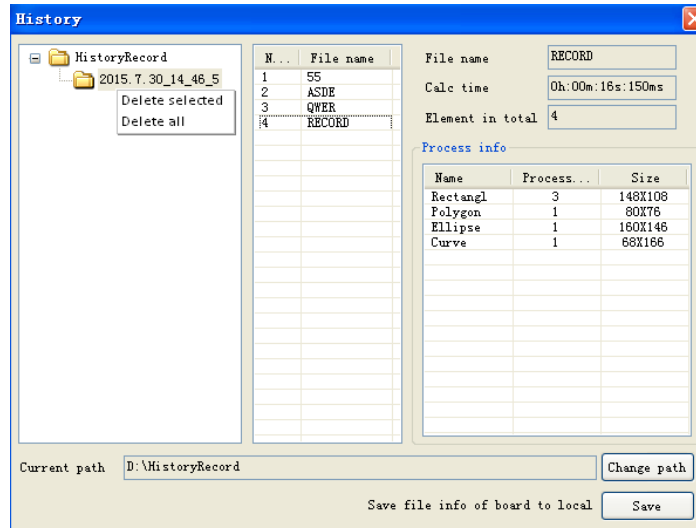

Fig 3-15

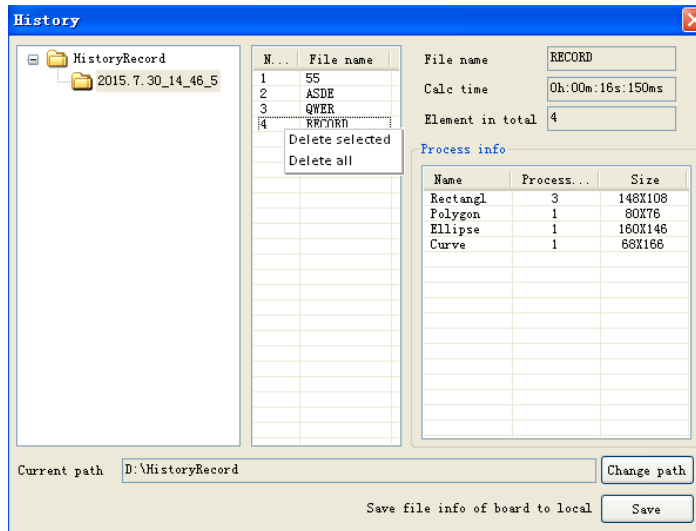

Fig 3-16



3.4.5 Information

Layer Process Test Documents Info

Accumulated Open time:

Accumulated Process time:

Previous process time:

Accumulated Light time:

Accumulated process num:

X accumulated route (m):

Y accumulated route (m):

Mainboard version:

Read Update Password

Fig 3-5

Accumulated open: the total time of the mainboard in power on status.

Accumulated process time: the total time of the working. Include the moving time.

Previous process: the time of the last process.

Accumulated Light time: the total time of the laser in laser on status.

Accumulated process num: the number of the working , but the number is not include the work be stopped

X accumulated route(m): the total distance of the axis X.

Y accumulated route(m): the total distance of the axis Y.

Mainboard version: the version of the current mainboard.

Read: press the button to read the information of the mainboard.

Lock/Unlock: when press the button at first, user must press the “Reset” of the control panel in machine. after done it , the machine can be lock. And press the button again and press the “Reset” of the control panel again, then the machine is unlock.

Update: User can update the mainboard if have the “*.upd” file which is provide by factory.

Password: When the machine is locked, click this button to get request code , and send it to vender for getting register code. Don't exit this dialog window before input the register code , or the register code can not fit to the request code.

Password

Request code: 852674607

Register code:

Don't exit before enter register code!

OK

Fig 3-6





3.4.6 Data Process

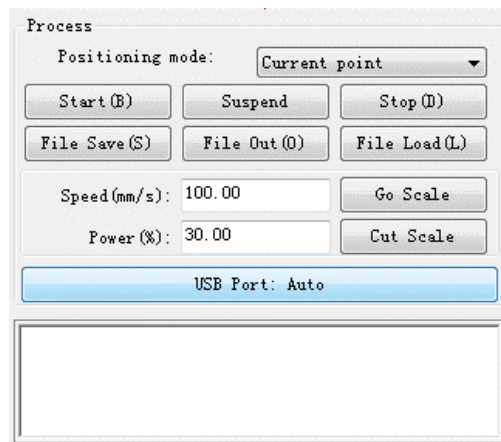

Fig 3-7

- ◇ **USB Port: Auto:** Link device in two different ways: USB and Network. But through USB port button on the popup dialog box, set connection mode and choose connection port.

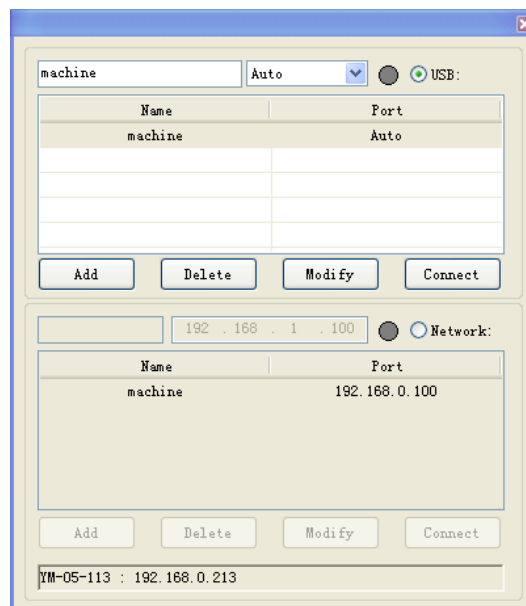

Fig 3-8

If the computer connected to a laser device , option can be set to automatically, the software will automatically determine the determine the connection with the device interface

When computer connection has many sets of laser equipment, click add, user need to use which device ,click the check box

Click on **【add】** or **【modify】** ,can him out of the dialog box as shown above to **【add】** or **【modify】** can click on the **【Connect】** to connect with the device

Network: If the computer is connected to laser device, click on the add , enter to connect machine name and IP address of the equipment





When a computer is connected with many sets of laser equipment, click add, which can use new device, click the check box

Click on the **【add】** or **【modify】** will he a dialog box as shown above to **【add】** or **【modify】** after clickable **【Connect】** detect and equipment connection is successful

Search at present already connected device, and choose from the drop-down list corresponding IP address machine.

- ◇ **Position:** Setting the laser head back location after processing completed.(Current position、Original anchor、Machine Zero.

Current Position : Laser head back to the position before processing.

Original anchor : Laser head back to the last anchor ,the anchor may set at panel.

Machine zero : Laser head back to the zero of the machine.

- ◇ **Go Scale、Cut Scale**

For Example Go Scale, As the following figure shown, the actual graphic is round, and the red rectangle outside the circle is the smallest rectangle, click button Go Scale, laser head will run once along the rectangular path.

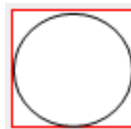

Fig 3-9

For Example Cut Scale, As the following figure shown, the actual graphic is round, and the red rectangle outside the circle is the smallest rectangle, click button Cut Scale, laser head will be cut along the rectangle.

- ◇ **Start、Suspend、Stop、File Save、File Out、File Load**

Start: Output the current graphic to the machine for processing, the shortcut key is ALT+B.

Pause/Continue: Click Pause, will stop the processing work, click the button again to Continue

Stop: Stop the current processing work, the shortcut key is ALT+E.

File Save: Save current file as “*.oud” format , using for offline processing (Can be copied to other memory board for full offline operation) , the shortcut key is ALT+S.

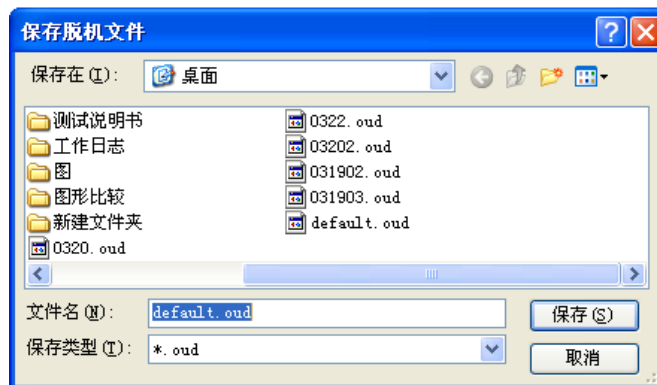

Fig 3-10





File Out: Output the offline file (oud format).After save offline file, click “File Out” to select oud file to processing, the shortcut key is ALT+O.



Fig 3-11

File Load: Download the file to the memory of the controller , then user can start the file through the machine panel, the shortcut key is ALT+L.



Fig 3-12

Information: Display the information of the mainboard.

Connect: there are two ways of communication with mother board, which is connecting by USB or net work.

USB: by default set to automatic mode. User can add different connect port to the list, then select it and click the button “connect”.

Network: by default, set the IP as 192.168.1.100. user can modify it, which must to be consistent with the motherboard.

Add: add new connect port to the list.

Delete: delete current port selected from the list.

Modify: modify info of current port selected of the list.

Connect: connect the motherboard as description of the port selected.

LED : green means the port can be connected, gray means the port can not be connected.

Local host IP information: The local host name and IP address are shown at the bottom of the dialog.





Chapter4 Pictures and Interfaces

4.1 Object Pictures of MainBoard

For more detailed pin description, see the Chapter 4: Description of Interface Signal for MainBoard.

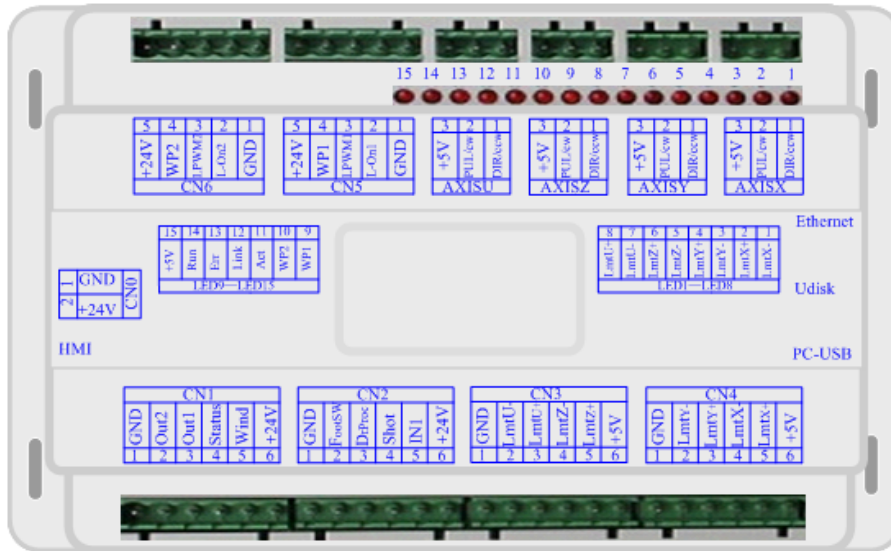

Fig 4-1

4.2 Object Pictures of Panel

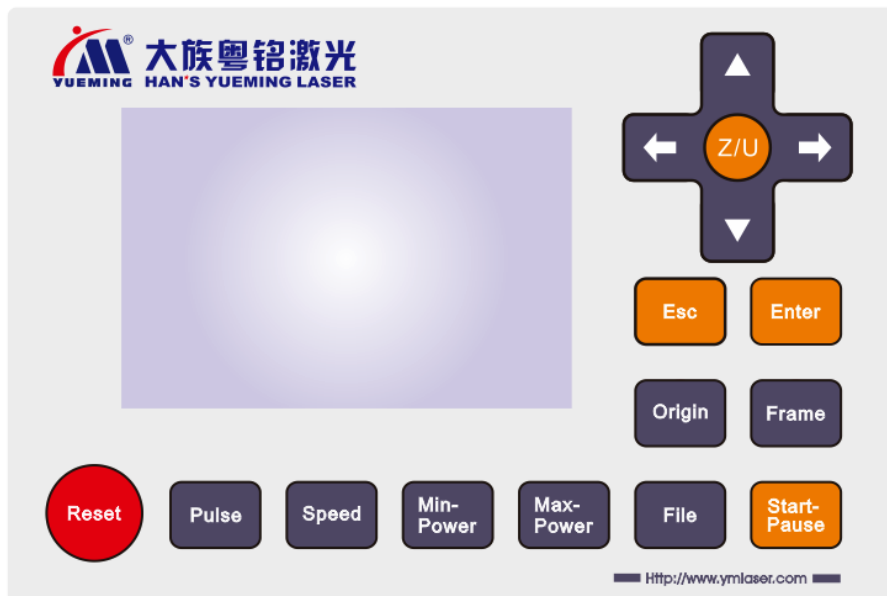

Fig 4-2





Chapter5 Operating Instruction of Panel

5.1 Introduction to the Panel and Keys

5.1.1 The whole panel

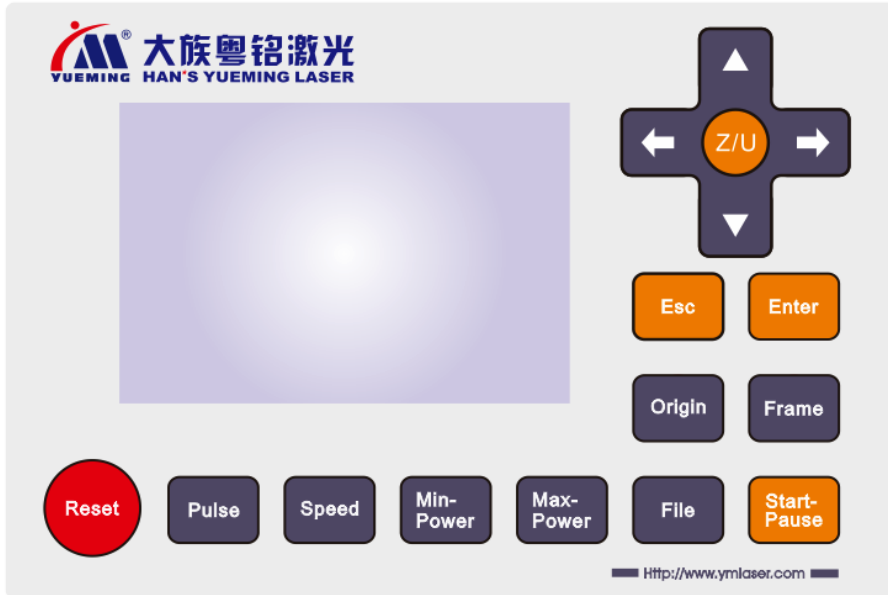

Fig 5-1

5.1.2 Introduction to the Keys



: Reset the whole system;



:Set the relative origin;



:Let the Laser to splash;



:To track by the current file's frame;



:The management of the memory and U disc files;



:Set the speed of the current running layer, or set the direction keys' move speed;



:Set the max laser power of the current running layer, or set the power of "Laser"

Key;



:Set the min laser power of the current running layer,





:To start or pause the work;



:To move the X axes or the left/right cursor;



:To move the Y axes or the up/down cursor;



:The Z/U key can be pressed when the system is idle or the work is finished. On pressing this key, it will show some entries in the interface, each entry includes some functions, Z axes move, U axes move, each axes to go home etc.;



:To stop work, or to exit to some menu;



: Validate the change;

5.2 Introduction to the Main Interface

5.2.1 The main interface

When the system is powered on, the screen will show as below:

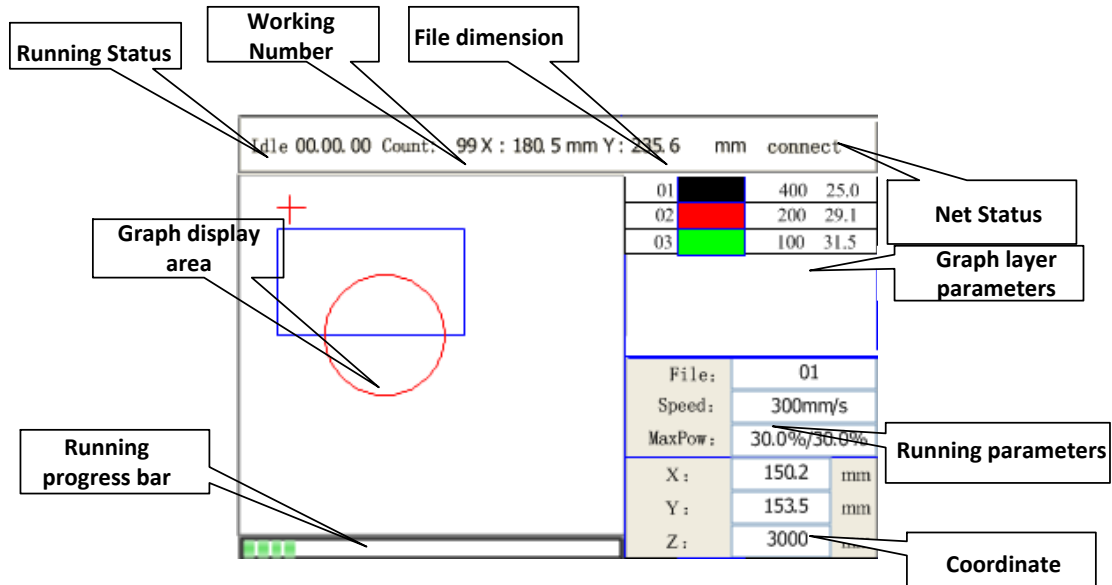

Fig 5-2

Graph Display Area: To display the whole file's track, and display the running track.

Running parameters: To display the running file's file number, speed, max power etc.;

Coordinate: To display the current coordinate of X,Y and Z axes



Graph layer parameters: To display the layers' information of the current file, such as max or min power, speed etc.. When system is idle, dblclick the layer, then users can change the layer's parameters and the changing would be saved.

Running Status: To display the current status of the machine, such as Idle, Run, Pause, Finish, etc.;

Running Progress Bar: To display the progress bar of the current running file;

Working Number: To accumulate the work number of the current file.

File Dimension: To display the dimension of the current file;

Net status: To display the connecting status of the Ethernet.

When work is Idle or finished, all keys can be pushed, users can select a file to run, set some parameters, preview to a select file etc. But, when work is running or paused, some keys don't respond when they are pushed.

5.2.2 Speed key

Push the "Speed" key when the screen is on the main interface, it will show as below:

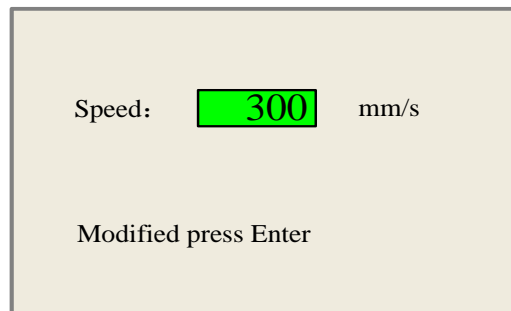

Fig 5-3

Push the "X+/-" Keys to move the cursor in the numeral area, and push the "Y+/-" keys to change the value, then push the "Enter" key to save the change, push the "Esc" key to invalidate the change.

5.2.3 Max/Min power keys

Push the "Max Power" or the "Min Power" keys when the screen is on the main interface, it will show as below:

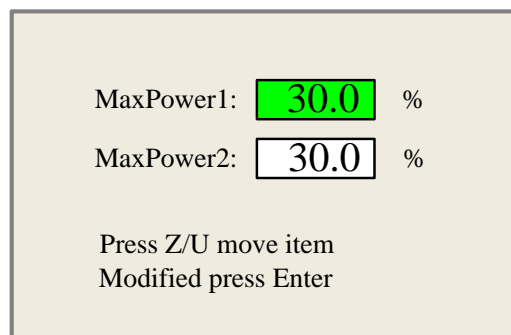

Fig 5-4



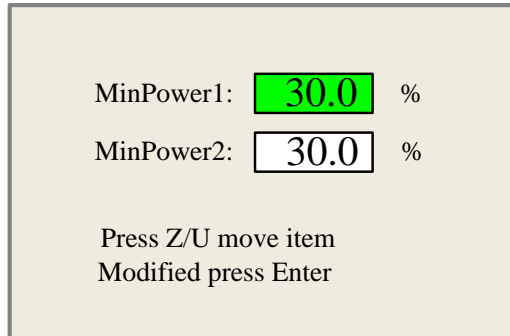

Fig 5-5

When “Z/U” key is pushed, the green block can move up and down to denote the changing item, then “Y+/-” keys and “X+/-” keys can be used to change the value.

5.2.4 Set the layer parameters

After selecting a file to preview on the main interface, user can push “Enter” key to let the cursor move to the first layer, then “Y+/-” Keys can be pushed to select the intent layer, on that time, user can push “Enter” key to check the selected layer’s parameters, show as below:

01		400	25.1
02		200	29.1
03		100	31.5

Fig 5-6

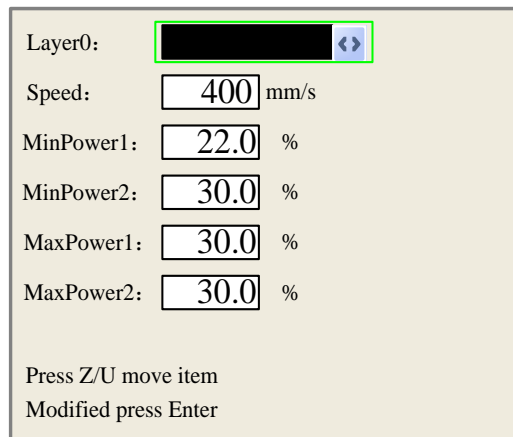

Fig 5-7

User can push “Z/U” Keys to move the green block on the intent parameter, then he could change the parameter if needed. “OK” to validate the change, and “Esc” to invalidate the change.

5.3 Z/U Key

The Z/U key can be pressed when the system is idle or the work is finished. On pressing this key, it will show some entries in the following interface:



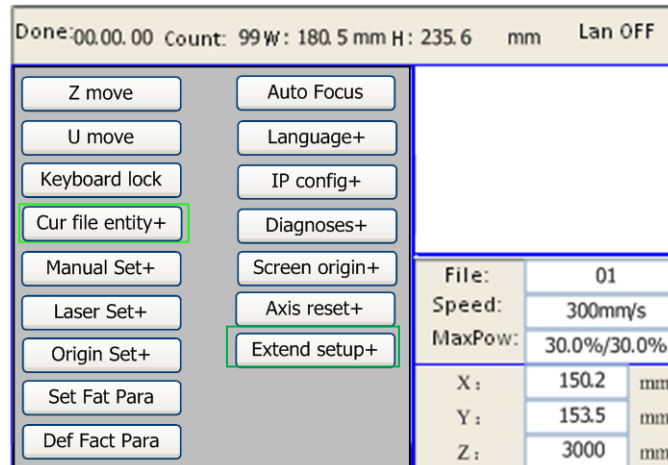

Fig 5-8

Push “Y+/-” keys to move the green block to the anticipant item, and then push the “Enter” key to display the sub menu.

5.3.1 Z move

When the green block is on “Z Move” item, “X+/-” keys can be used to move the z axes.

5.3.2 U move

When the green block is on “U Move” item, “X+/-” keys can be used to move the u axes.

5.3.3 Axis reset+

When the green block is on this item, push the “Enter” key to show as below:

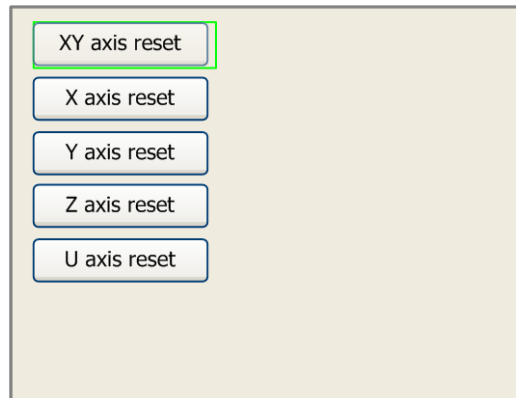

Fig 5-9

Push the “Y+/-” Keys to move the cursor to one of the entry, then push “Enter” key to restart the selected axis, the screen will show some information when resetting.





5.3.4 Cur file entity+

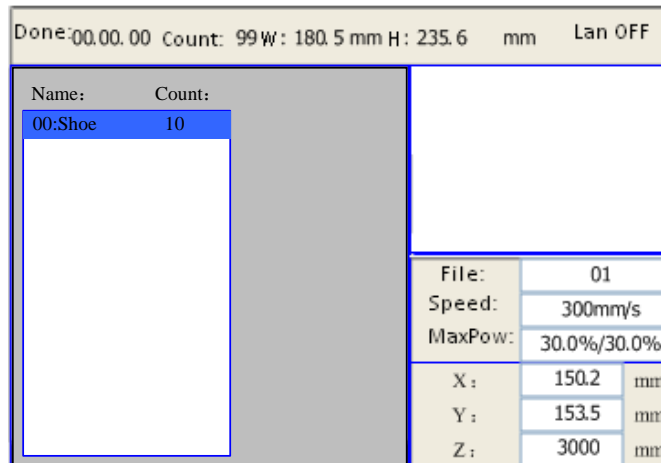

Fig 5-10 Current File Entity

When the machine is working, the number currently being processed displayed on the page is calculated according to the amount of processing data currently pressed by the mainboard, rather than the actual processed number, which means that the number of pieces is counted in advance. If the processing is stopped manually, the number of pieces is also recorded to the number of processed files. The obtained number may be larger than actually processed number.

5.3.5 Manual set+

When the green block is on this item, push the “Enter” key to show as below:

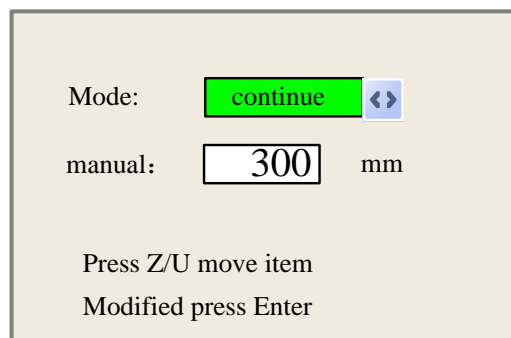

Fig 5-11

Push “Z/U” key to move the green block, and when the green block is on the “Mode” item, push “X+/-” keys to select the anticipant value, “Continue” or “Manual”. When “Continue” item is selected, then the “Manual” item is not valid, on that time, push the direction keys to move the corresponding axes, and when the pushed key is loosed, then the corresponding axes will finish moving. When the Mode item is “manual”, then pushing the direction key one time, the corresponding axes will move a fixed length, unless the scope is overstepped.

5.3.6 Laser set+

When the green block is on this item, push the “Enter” key to show as below:



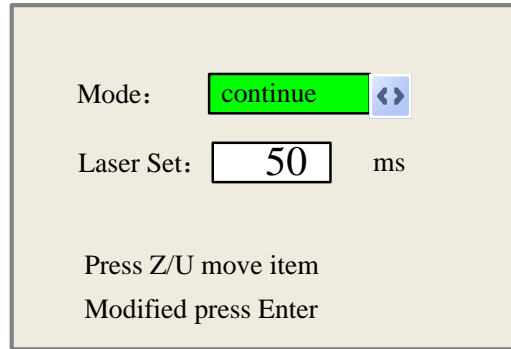

Fig 5-12

Push “Z/U” key to move the green block, and when the green block is on the “Mode” item, push “X+” keys to select the anticipant value, “Continue” or “Manual”. When “Continue” item is selected, then the “Laser Set” item is not valid, on that time, push the Laser key to splash the enabled lasers, and when Laser key is loosed, then the lasers will finish splashing. When the Mode item is “manual”, then pushing the Laser key one time, the enabled lasers will splash a fixed time.

5.3.7 Origin set+

When the green block is on this item, push the “Enter” key to show as below:

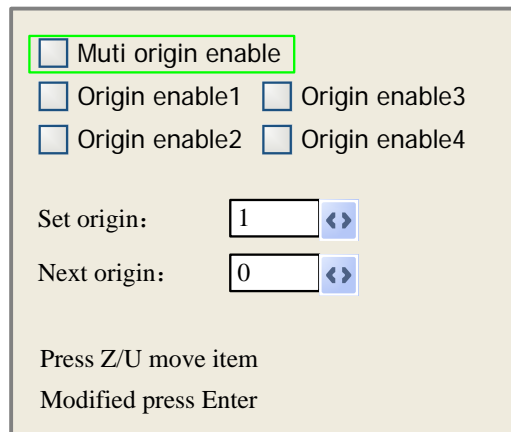

Fig 5-13

Push “Z/U” key to move the green block to the anticipant item, and when the green block is on “enable” items, push “Enter” key to enable or disable the item, when enabled, the small diamonds is green, and when disabled, the small diamonds is grey. When the green block is on the “Set origin” item or the “Next origin” item, push the “X+” keys to select the value.

Pay attention to if when the green block is on the “Set origin” item, push the “X+” keys to select a value, then, “Enter” key must be pushed to valid the change, or, the change is invalid.

Each item introduced as below:

- ✧ Multiple Origins Enable: “Yes” or “No” can be selected. If you select “No”, the system will use the single-origin logic. You can press the “Origin” key and set the origin, and only this origin can become valid. If you select “Yes”, the system will use the multiple- origin logic and the “Origin” key on the keyboard become invalid. In such a case, the parameter of each origin must be set in the menu as follows.
- ✧ Origin Enable1/2/3/4: after the multiple-origin logic is enabled, the four origins can independently be prohibited and enabled.





- ✧ Set Origin 1/2/3/4: after the multiple- origin logic is enabled, you can stop the cursor at “Set as Origin 1/2/3/4”. Press the “Enter” key on the keyboard and the system will take the coordinate figures of current X/Y axes as the corresponding ones to the origin 1/2/3/4.
- ✧ Next Origin: there are such five digits as 0~4 for option, which are the origins to be used for the next figure. Origin 0 means the origin set by the “Origin” key on the panel in the single- origin logic. 1~4 means the serial number of the origins in the multiple- origin logic. Next origin can be modified to any one of origin 1~4, so as to control the start location of next work (the premise is that the origin is enabled), but it can't be modified to origin 0.

 Note	<p>Once the multiple- origin logic is selected and if the serial number of the next origin is 1 and four origins are enabled, when the memory file function is started or the processing file is uploaded into the PC and this file selects “Take the Original Origin as current Origin”, the work started for each time will use different origins. The rotation order of origin is 1->2->3->4->1->2.....</p>
--	---

5.3.8 Set Fact Para

After the “Set Fact Para” is selected and the Enter key pressed, the interface will show the specific password to be entered when set as default parameter.



Fig 5-14

Push “X+/-” keys and “Y+/-” keys to select the characters, and push the “Enter” key to valid the characters, when finishing enter the password ,that is to say, the six characters, if the password is error, it prompts there is some error, or, all parameters are stored.

 Note	<p>After the manufacturer regulates all parameters of the machine well (including all manufacturer parameters and user parameters), this function can be used to store the well-regulated parameters to help users to recover the original parameters (including all manufacturer parameters and user parameters) through selecting “Recover Para” when they regulate parameters improperly.</p>
--	--

5.3.9 Def Fact Para

After the “Def Fact Para” is selected and the Enter key pressed, the “Successful Recovery” dialog box will pop up to prompt that all manufacturer parameters and user parameters are recovered successfully. You can return to the previous menu by press the Enter key.





5.3.10 Auto Focus

When the cursor stops at “Auto Focus”, press the Enter key to search for the focus(When there is z axes, and the z axes reset function is enabled, the auto focusing is valid); press the Esc key to return the prior menu.

5.3.11 Language

The item “Language” helps you to select a appropriate langue which is displayed on the pane:



Fig 5-15

5.3.12 IP Setup

When the green block is on this item, push the “Enter” key to show as below:

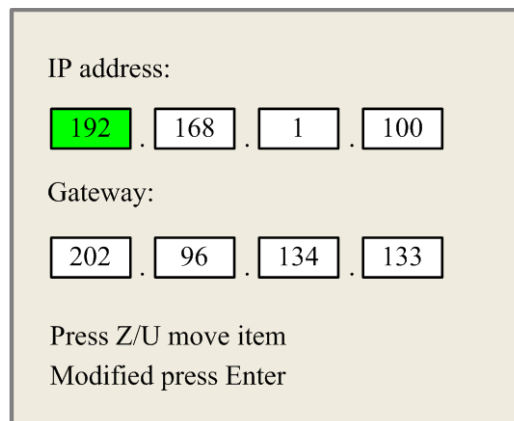

Fig 5-16

Push “Z/U” key to move the changing item, then push “X+/-” keys and “Y+/-” keys to change the value, when all the IP value and the Gateway value are changed, push “Enter” key to validate the change, or “Esc” key to invalidate the change.

5.3.13 Diagnoses

If the “Diagnoses” item is pressed, the system will show as below:



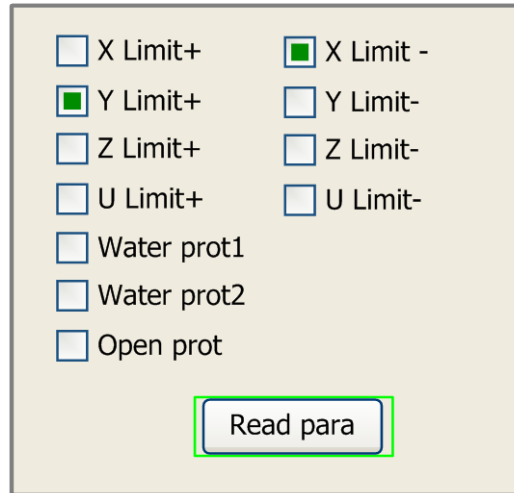

Fig 5-17

This interface shows some system input information, such as limiter status, the status of the water protecting, and the status of the foot switch etc.. When the input is validated, the color frame will be green, otherwise it's gray.

5.3.14 Screen Origin

If the "Screen Origin" item is pressed, the system will show as below:



Fig 5-18

There are four entries to be selected: Top Left, Top Right, Bottom Left and Bottom Right. When one is selected, the previewed graph on the screen would be enantiomorphous based on X or Y direction.

 Note	This item is only used to preview the file on the screen, and it is no meaning to the machine's movement.
-----------------	---





5.3.15 Extend setup+

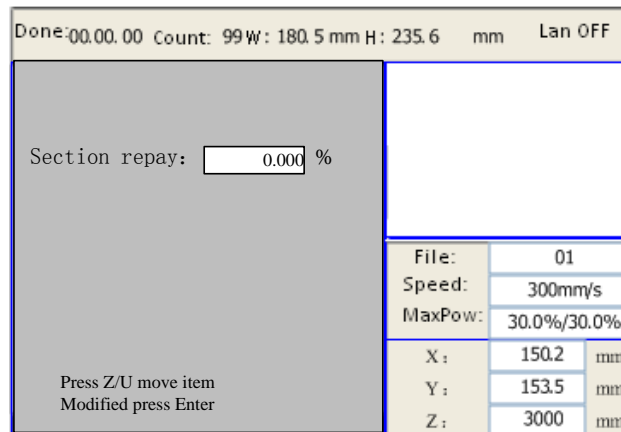

Fig 5-19

Section repay: This parameter and “Compensation (%)” of SmartCarve4.3 software have exactly the same functions, that is, the parameter can be set either by SmartCarve4.3 software or the panel.

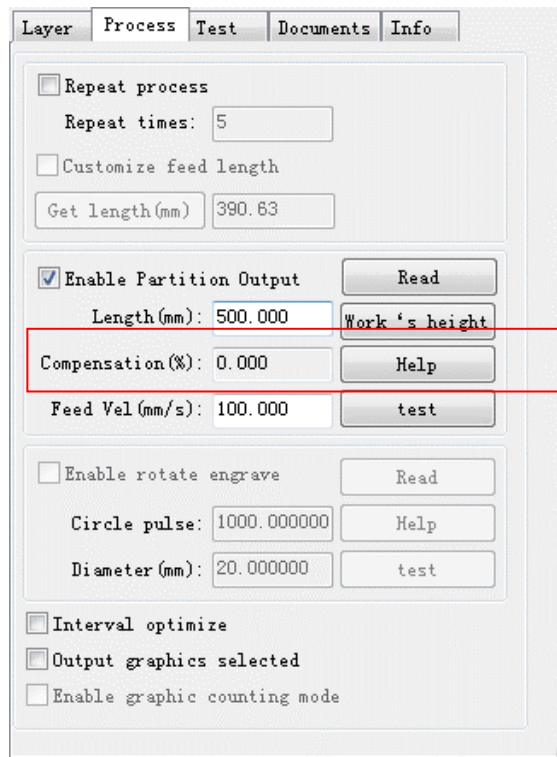

Fig 5-20

5.4 File Key

5.4.1 Memory File

On the main interface, if “File” key is pressed, it will show as below:



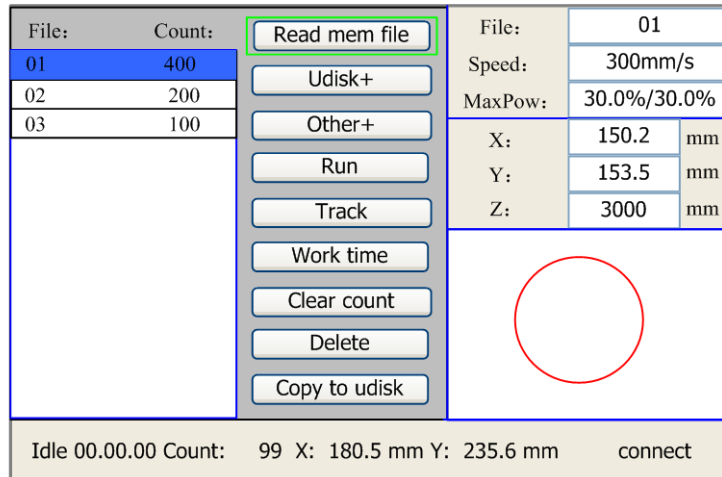

Fig 5-21

When showing this menu, the system would read the memory file firstly, the file name and the work times would be listed in the area, and the selected file is previewed in the bottom right area. “Y+/-” keys could be used to move the cursor on the file name list.

When the cursor is on a target file name, presses the “Enter” key, the selected file will be previewed on the main interface, and then if “Esc” key is pushed, the preview will disappear.

“X+/-” keys could be used to move the cursor left and right. All the item show as below:

- 1) **Read mem file:** read the memory file list;
- 2) **Udisk:** read the U disk file list;
- 3) **Other:** the other operation of the memory files;
- 4) **Run:** To run the selected file;
- 5) **Track:** To track the selected file, and the track mode is optional;
- 6) **Work time:** To forecast the running time of the selected file, and the time is accurate to 1ms;
- 7) **Clear count:** To clear the running times of the selected file;
- 8) **Delete:** To delete the selected file in the memory;
- 9) **Copy to Udisk:** To copy the selected file to Udisk;

If the “Other” entry is pressed, the system will show as below:

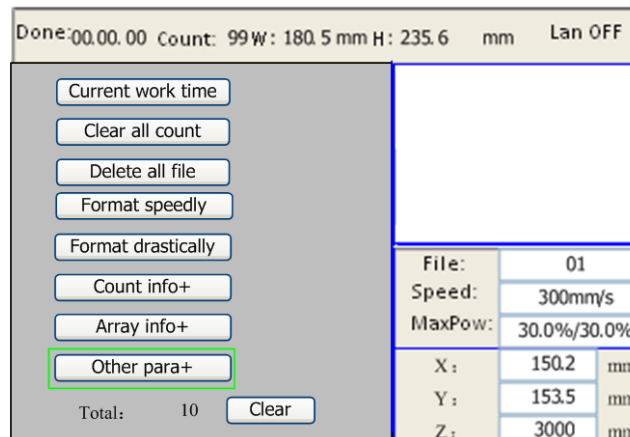

Fig 5-22

- ✧ **Current work time:** To forecast the running time of the current file(the current file No. is showed on the main interface), and the time is accurate to 1ms.
- ✧ **Clear all count:** To clear the running times of every file in the memory
- ✧ **Delete all file:** To delete all memory files
- ✧ **Format speedily:** To format memory speedily, and then all the files in memory will be deleted.
- ✧ **Format drastically:** To format memory drastically, and then all the files in memory will be deleted.
- ✧ **Total:** the total running times of all the files.
- ✧ **Count info+:** To display the count of each entity in the current file.

Done:00.00.00 Count: 99 W: 180.5 mm H: 235.6 mm Lan OFF													
Name:	Count:												
01:Name	66												
02 :Name2	24												
<table border="1"> <tr> <td>File:</td> <td>01</td> </tr> <tr> <td>Speed:</td> <td>300mm/s</td> </tr> <tr> <td>MaxPow:</td> <td>30.0%/30.0%</td> </tr> <tr> <td>X :</td> <td>150.2 mm</td> </tr> <tr> <td>Y :</td> <td>153.5 mm</td> </tr> <tr> <td>Z :</td> <td>3000 mm</td> </tr> </table>		File:	01	Speed:	300mm/s	MaxPow:	30.0%/30.0%	X :	150.2 mm	Y :	153.5 mm	Z :	3000 mm
File:	01												
Speed:	300mm/s												
MaxPow:	30.0%/30.0%												
X :	150.2 mm												
Y :	153.5 mm												
Z :	3000 mm												

Fig 5-23

If an offline file does not have count information, it doesn't support to array information view and modification, and the mainboard will prompt **"The file format is not supported"**.

Done:00.00.00 Count: 99 W: 180.5 mm H: 235.6 mm Lan OFF													
Name:	The file format is not supported												
	Esc												
<table border="1"> <tr> <td>File:</td> <td>01</td> </tr> <tr> <td>Speed:</td> <td>300mm/s</td> </tr> <tr> <td>MaxPow:</td> <td>30.0%/30.0%</td> </tr> <tr> <td>X :</td> <td>150.2 mm</td> </tr> <tr> <td>Y :</td> <td>153.5 mm</td> </tr> <tr> <td>Z :</td> <td>3000 mm</td> </tr> </table>		File:	01	Speed:	300mm/s	MaxPow:	30.0%/30.0%	X :	150.2 mm	Y :	153.5 mm	Z :	3000 mm
File:	01												
Speed:	300mm/s												
MaxPow:	30.0%/30.0%												
X :	150.2 mm												
Y :	153.5 mm												
Z :	3000 mm												

Fig 5-24

- ✧ **Array info+:** To modify the array information of the current file.

Move the cursor to the "Array info+", and press the "Enter" button to pop up subordinate page, which is the information of selected arrays, as follows:

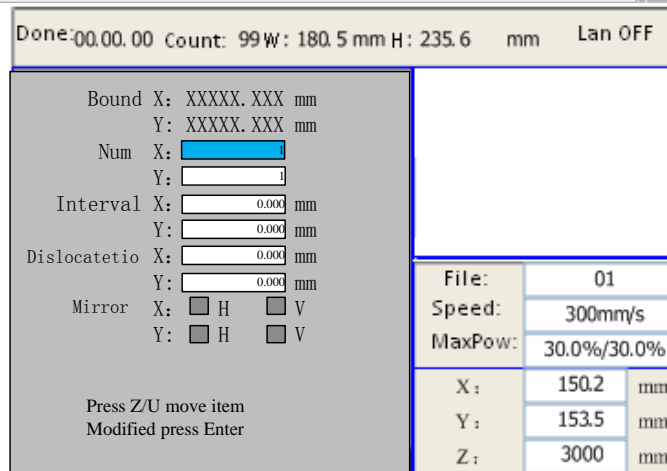

Fig 5-25

Bound: the size of XY border of the main entity of the virtual array;

Num: numbers of arrays in XY direction respectively; *X* corresponds to the number of columns of SmartCarve4.3, and *Y* corresponds to the number of rows of SmartCarve4.3.

Interval: interval value in XY direction; the interval is back to back interval of two entities, rather than center interval; a positive number indicates the interval with positive coordinate, and a negative number indicates the interval with negative coordinate. *X* corresponds to the column spacing of SmartCarve4.3, and *Y* corresponds to the row spacing of SmartCarve4.3.

Dislocatetio: whether to dislocate even columns and rows; a positive value indicates dislocation in positive coordinate direction, and a negative value indicates dislocation in negative coordinate direction. *X* corresponds to the column dislocation of SmartCarve4.3, and *Y* corresponds to the row dislocation of SmartCarve4.3.

Mirror X: *H*- corresponds to mirror operation in *X* direction of column mirror of SmartCarve4.3, and *V*-- corresponds to mirror operation in *X* direction of row mirror of SmartCarve4.3;

Mirror Y: *H*- corresponds to mirror operation in *Y* direction of column mirror of SmartCarve4.3, and *V*-- corresponds to mirror operation in *Y* direction of row mirror of SmartCarve4.3;

Except XY boarder size, all other information can be modified.

If a file contains more than one array, all the information can't be modified. If the file is over-format split cutting, it doesn't support array information view.

❖ **Other Para+**

Move the cursor to the "Other Para" and press the "Enter" to enter the parameter interface.

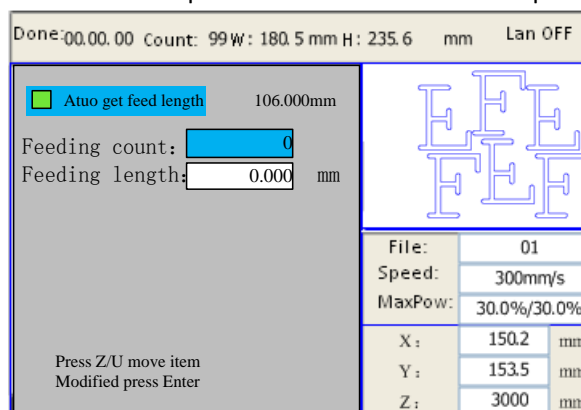

Fig 5-26





Auto get feed length: If this option is checked, then the mainboard can calculate the feeding length after modify the array information on the HMI, and also there would display the feeding value on the right side of the option.

Feeding count: Set the cycle count of this file.

Feeding length: User can set the feeding length by manual, If the “Auto get feed length” option is checked, then this parameter is invalid

5.4.2 U Disk File

If the “Udisk” entry in figure 5-18 is pressed, the system will show as figure 5-20, and the operation method is all the same as figure 5-18.

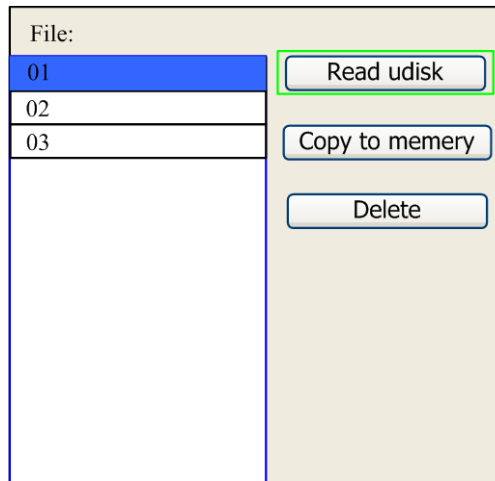

Fig 5-27

- ✧ **Read Udisk:** read the file list in the Udisk;
- ✧ **Copy to memory:** copy the target Udisk file to the memory;
- ✧ **Delete:** delete the selected Udisk file;

<p>Note</p>	<p>This system supports such file formats of Udisk as FAT32 and FAT16, but it can identify them when the files are put under the root directory of Udisk. The file name of more than 8 characters will automatically be cut out by the system. The file name that has only English letters and digits will not show when they are copied to the mainboard. The files copied from the mainboard to Udisk will be placed under the root directory of Udisk.</p>
--------------------	---

5.5 Introduction to some alarm info

When users are operating the system, or when the machine is running, some alarm information such as water protecting error maybe shows as below:



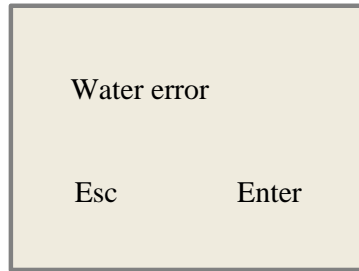

Fig 5-28

Push “Enter” key or “Esc” key, the system will execute some relative steps.





Chapter6 Manufacturer/User Parameters Explanation

6.1 Manufacturer parameters

1) Motor parameters

X/Y/Z/U axle parameters

Direction Polarity: Modification of direction polarity can move the motor to the opposite direction. The modification purpose can move this axle to the origin on resetting. If this axle moves far from the origin on resetting, it means the direction polarity of this axle is wrong in setting and should be modified.

Spacing Polarity: it is used to set the high and low level mode of spacing signal. When the motion axle arrives at the spacing position and input a low-level signal to the mainboard, the spacing polarity at this time should be set to be minus.

scope: it means the farthest distance that the motion axle can move, which is determined in accordance with the actual condition of the machine.

Distance from Origin to Hard Spacing: if this axle enables hard-spacing protection, generally this value should be set to be 2~5mm; if it is set to be 0, when this motion axle moves to the smallest coordinate, i.e. 0, this spacing may be validate, which may wrongly triggers the hard-spacing protection and scam the machine. If the hard-spacing protection is not enabled, this value can be set to be 0~5mm.

Control Mode: Double pulse or direction+single pulse are optional, in general, direction+single pulse is selected.

Motor Stepping: it means the impulse equivalent, the absolute distance gone by the corresponding motion axle when a pulse is delivered to the motor. Prior to the correct setting of this value, a large rectangle can be cut with the machine (the larger the figure is, the smaller the difference is). The motor stepping can automatically be calculated according to the figure length and measuring length.

Hard-spacing Protection: it is used for whether the hard-spacing protection of this axle is enabled.

PWM Rising edge valid : To set the motor driver's pulse signal rising edge valid or falling edge valid. If this item is disabled, the pulse is falling edge valid, or, it's rising edge valid.

Reset Enable: if the machine is provided with this axle, its "Reset Enable" should be opened; if no, its "Reset Enable" should be prohibited.

Takeoff Speed: it means the speed of the motion axle in direct start from the idle condition. If this value is excessively large, it will make the motor lose steps, jar and even squeak; if small, it will reduce the running speed of the whole figure. If the inertia of the motion axle is larger (the axle is heavier), you can set a smaller takeoff speed; if smaller (the axle is lighter), you can increase the takeoff speed. For example, the typical value is 5~30mm/s.

Maximum Speed: it means the maximum limit of motion speed that this axle can bear. This parameter has something to do with the driving force of motor, the inertia of motion axle and its drive ratio. For example, the typical value is 200~500mm/s.

Maximum Acceleration: it means the maximum acceleration of the motion axle in accelerated or decelerated motion. If the acceleration is set too large, it will make the motor lose steps, jar and even squeak; if too small, it will cause the reduction of acceleration so as to reduce the running speed of the whole figure. For





the axles with larger inertia, such as Y axle corresponding to the beam, its typical setting range is 800~3000mm/s²; for the axles with smaller inertia, such as X axle corresponding to the car, its typical setting range is 8000~20000mm/s².

Scram Acceleration: if this axle enables the hard-spacing protection, when this axle moves to the spacing position, it will scam operation at the scam acceleration. This value can be 2~3 times of the maximum acceleration for this axle.

Key parameters

Key Move Takeoff Speed: it means the starting speed to move this axle by way of the keys on the keyboard, which can't be higher than the takeoff speed.

Key Move Acceleration: it means the acceleration to move this axle by way of the keys on the keyboard, which can't be higher than the maximum acceleration of this axle.

Key Polarity: it is used to control the movement direction of the axle that is moved through manual operation of the keys. After the direction polarity is correctly set, if you press the directional keys on the operating panel, this axle will move to the opposite direction. In such a case the polarity of keys should be modified.

2) **Laser parameters**

Laser Configuration: single laser and double lasers are available for option and set in accordance with the laser-tube quantity provided by the manufacturer.

Laser Type: glass tube, RF laser (not need pre-ignition pulse) and RF laser (needing pre-ignition pulse) available for option.

Laser Attenuation Quotiety

Laser Enable: When double lasers are used, then each laser can be respectively enabled or disabled.

Minimum Power

Maximum Power

Laser PWM Frequency

Pre-generation Frequency

Pre-generation pulse scale: When the laser is RF-laser and it's need to pre-generate PWM, then set the Pre-generation Frequency and the Pre-generation pulse scale.

Water Protector Enabled: When the water protector is enabled, the mainboard will detect the input port of water protector. If this port is of low level, it will be deemed normal; if this port is of high level, the mainboard will forcibly close the laser to suspend the work in progress and the system will warn. If the water protector is not enabled, the mainboard will not detect the input port of water protector and so the water protector can be unconnected.

Laser PWM Frequency is used to set the pulse frequency of control signal used by this laser, in general, glass tube is about 20KHZ, RF laser is about 5KHZ; the maximum/minimum power (%) is used to set the limit power of this laser, that is to say, during the operation, the maximum power set by the user can't be higher than that set here and the minimum power set by the user can't be less than that set here, either. When a laser's power is attenuated, then the laser attenuation quotiety may be set

 Note	If it is only provided with the single laser, it can show the one-path parameter.
--	---





3) Other manufacturer parameters

Machine configuration

Machine Type: In most cases, the general engraving machine should be selected and other types used for specific purposes.

Transmission Mode: generally the “Belt Stepping Type” should be made choice of. The control algorithm will be changed a little when other types are selected.

Feeding Mode: it has single-way mode and two-way mode for option. If it is of single-way feeding, it is unnecessary to check the coordinates. Feeding can be conducted in the single-way mode; if it is of two-way feeding, the system will check the maximum and minimum coordinates. The odd sequence means feeding should be done to one direction and the even sequence means feeding done to the other direction. The initial direction for the first time can be changed through setting the directional polarity or modifying the plus and minus values of the feeding length.

Power-Off-Restart Delay: it can be set to be 0~3000ms. After the power-off of the electricity grid, the power supply of the system will not drop to 0 at once. There is a delay during this time. The delay value set here should basically consistent with the actual off-delay value. If the deviation of set value is larger, on the de-energizing for continuous engraving, either the figure processed for the second time is not closed with that before the cutoff, or it is coincided with that too much.

 Note	After the configuration parameters in the manufacturer parameters, such as directional polarity, control mode, laser type and laser PWM frequency, are modified, the system should be reset. Such a modification can function upon the resetting of the system.
--	---

Enable parameters

Door Opening Protection: If this item is enabled, then the door opening protection must be connected to the controller, or, the machine will not run.

Whether to enable the blower: If using wind out port to control the blower by the graph layer parameter, this item must be enabled, or, the wind output is a signal for other using.

Enable double head cutting: If this item is enabled, the graphs are automatically output cutting by system.

Head distance: This parameter must be set while the item “Enable double head cutting” is enable. It means the assemble distance between the two laser heads;

6.2 User parameters

1) Cutting parameters(Only affect cutting arts)

Idle Move Speed: this parameter decides the highest speed of all non-lighting lines for the machine in the movement process.

Idle Move Acceleration: it means the highest acceleration of all non-lighting lines. Idle stroke speed and idle stroke acceleration can be set higher to reduce the working time of the whole figure, but if they are set too high, it may cause the jarring of track, so comprehensive consideration should be given to the setting.

Turning Speed: it means the speed of turning at the acute-angle corner, which is also the highest speed in the whole cutting process.

Turning Acceleration: it means the acceleration of turning at the acute-angle corner when cutting. If the two speeds are set too high, jarring will happen to the turning; if set too low, it will influence the cutting speed.





Cutting Acceleration: it means the highest acceleration value in the whole cutting process.

Cutting Mode: it is divided into high-speed cutting and precision cutting. In high-speed cutting, priority is given to the cutting speed, but in precision cutting, the cutting effect.

Acceleration Mode: it is divided into T acceleration and S acceleration. T accelerate will quicken the whole cutting process, but it will result in that its cutting effect is inferior to that of S acceleration.

Idle Move Delay : If this parameter is zero, then after idle moving there is no delay, or, there is delay and the speed will decrease to turn off speed.

2) Scanning parameters(Only affect scanning arts)

X-axis Starting Speed

Y-axis Starting Speed

X-axis Acceleration

Y-axis Acceleration

The above four parameters are used to set the starting speed and acceleration of two axes on the scanning. The higher the two speeds are, the quicker the scanning is.

Scanning Line-feed Speed: this parameter is specially used to control the highest speed at which that the previous line vertically moves to the next line in the scanning mode. If the space between lines is larger during the scanning or if the distance of each block is larger during the scanning and deblocking of figure, it is necessary to position each line or block accurately. In such a case the speed of scanning line-feed can be set as a lower value.

Scanning Mode: it is divided into general mode and special mode for option. If special mode is used, the laser power should be increased. The smaller the speckle percentage is, the more the laser power reduces. The laser power to set should be larger in order to reach the same scanning depth. The purpose to select the special mode is to make the laser light at high power and short time. On the depth scanning the effect that the bottom is flatter is obtained, but it should be noticeable that if the speckle adjustment is not appropriate, it can achieve this goal. If the high power remains short, the lighting mode will influence the life of the laser. The system will default the selection of general mode.

Speckle Size: When the general mode is selected as the scanning mode, this parameter will become ineffective; when the special mode is selected, this parameter will become effective. The controller will control this parameter among 50%~99%.

 Note	The cutting and scanning parameters can't exceed the limited ones in the axle parameters. If so, the setting will become ineffective and the system will automatically cover the parameters with the axle parameters.
--	---

3) Feeding parameters

Before-feeding Time Lag: settable at 0~300s. The lagged time can facilitate user's feeding and picking on the feeding device.

After-feeding Time Lag: settable at 0~9.9s. It can facilitate the feeding device's delaying in jarring after moving to the correct position and waiting for the 2nd work after the feeding axle stands still completely.

Progressive feeding: If this item is enabled, then the dummy array graph on Y direction will run in the same position, running one line graph, the U axes moving one time to feed, the moving length of U axes is the interval of the two lines graph on Y direction.





Progressive feeding repay: Because of the imprecision of U axes' moving, there can set a value to repay the interval of the two lines graph on Y direction.

4) Reset parameters

Reset Speed: it means the speed of X/Y-axle linkage reset to the origin.

X axle start-up reset(Auto home)

Y axle start-up reset(Auto home)

Z axle start-up reset(Auto home)

U axle start-up reset(Auto home)

You can select "Yes" or "No" in the field of the above four parameters, which is used to confirm whether each axle can be reset on the startup.

5) Go scale parameters

Go scale Mode: "Blanked Bordering" means idling to start border preview; "Outputted Border Cutting" can manually cut off the well-processed figure; "4-corner Dotting" means to emit the light at four corner points of the frame to make a point and turn off light. The size and position of this figure can be checked intuitively through the four points. The bordering speed is the speed value set on the keyboard when the system is idle. For light output, its minimum/maximum power is the corresponding value set on the keyboard when the system is idle (The lasering power on the 4-corner dotting means the well-set maximum power).

Go scale Blank: It means whether to extend a certain length outside the actual frame of the figure on the preview/cutting of frame.

 Note	If the frame crosses the border, the interface will prompt it. If the Enter key is pressed at this time, the system will cut the border at the maximum/minimum coordinates first, and then border the figure. This bordering can be given up.
--	---

6) Other user parameters

Array Mode: Two-way array or one-way array can be selected. Two-way array means the to-and-fro cutting of array in sequence; one-way array means the cutting of array from one direction to another. On selecting one-way array, the elements of each array are the same in action mode and completely uniform in action fluency, which takes a little more time than two-way array. Two-way array is the default option.

Back Position: The origin (the relative origin) and the machine's absolute origin can be selected. This parameter decides the parking position of laser head after each work.

Focus Setting: it means the distance from the focal point of laser head lens to Z-axle origin. When there is no automatic focusing function, this parameter becomes invalid.

Backlash X: The X axes' backlash, accurate to 1um.

Backlash Y: The Y axes' backlash, accurate to 1um.

Enable rotate engrave: set this parameter to enable this function.

Circle pluse: number of pluse for turning the motor shaft one rotation .

Diameter: The workpiece diameter.

Test: It will send pluse as setting of circle pluse to turn the motor shaft. If it is not a circle turning, click the help button to set.





Help: Click this button to show the dialog of setting circle pluse.

6.3 How to set the parameter of the electronic double head mode

If user want to use the electronic double head output, then must set the parameter as below.

- 1) Press the menu “Tools(T)” → “Machine Setting(S)” to enter the dialog as below:

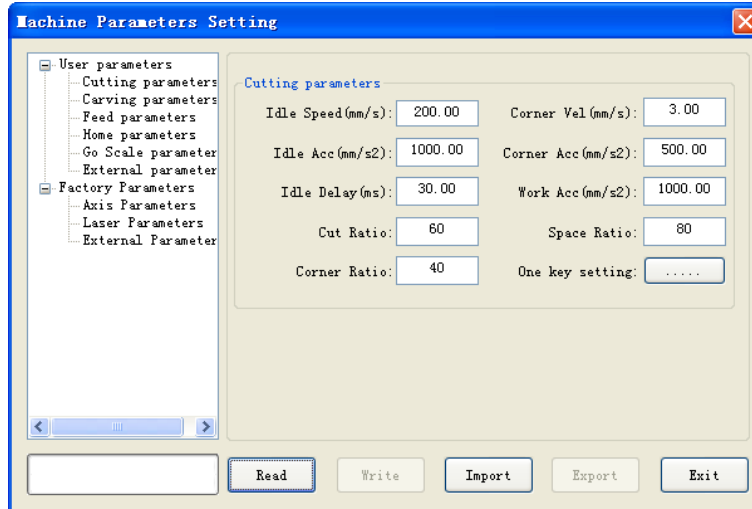

Fig 6-1

- 2) Select “Factory Parameters”, enter the password “ym9999”.

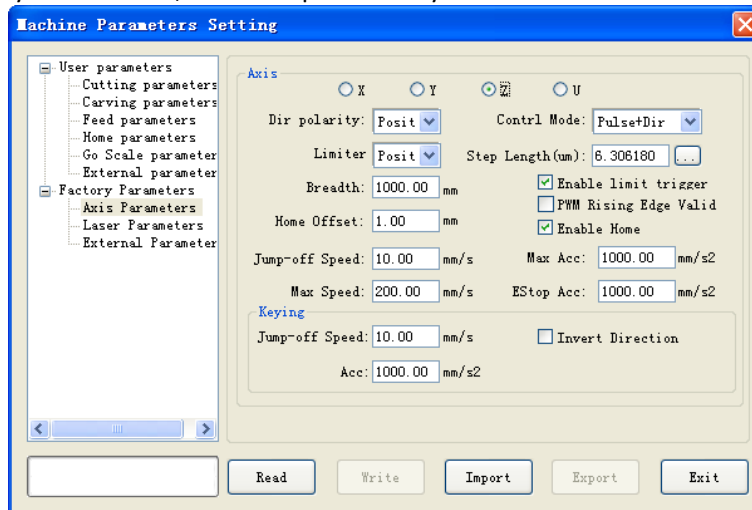

Fig 6-2

- 3) Choose “Z” option, and choose the “Enable Home” and “Enable limit trigger” parameters. The next step is to set the “Breadth”. At first, reset the machine and move the axis-X to the max range. And you can see the position of the axis-X in the control panel on the machine. Then set the “Breadth” value less than this value.(Attention: the breadth of axis-X and axis-Z must be same.)
- 4) Select the “Laser Parameter” option.



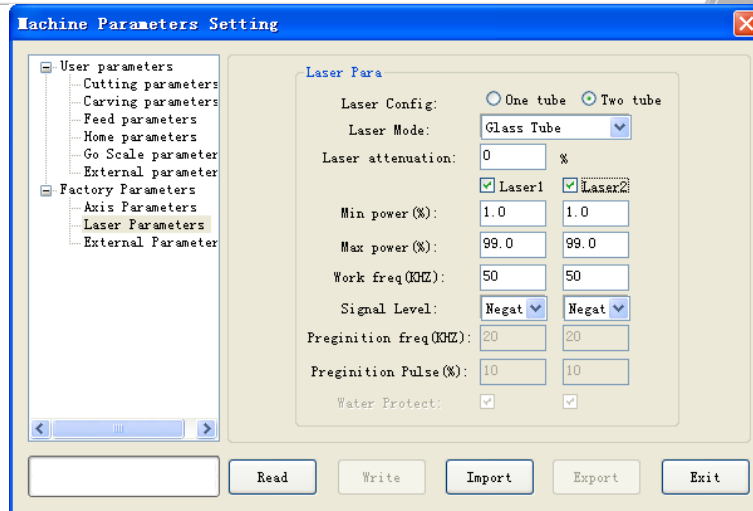

Fig 6-3

- 5) Choose the “Two tube” option and set the parameter of the laser.
- 6) Select “External Parameter” and choose the option “Enable blower” and “Enable Double Head Cutting”, also need to set the “Head distance(mm)” parameter. (At first, User need to reset the machine , after the axis-X and axis-Z have go back to home position, then press the “Pulse” button on the control panel. Then measure the distance between the two dot.)

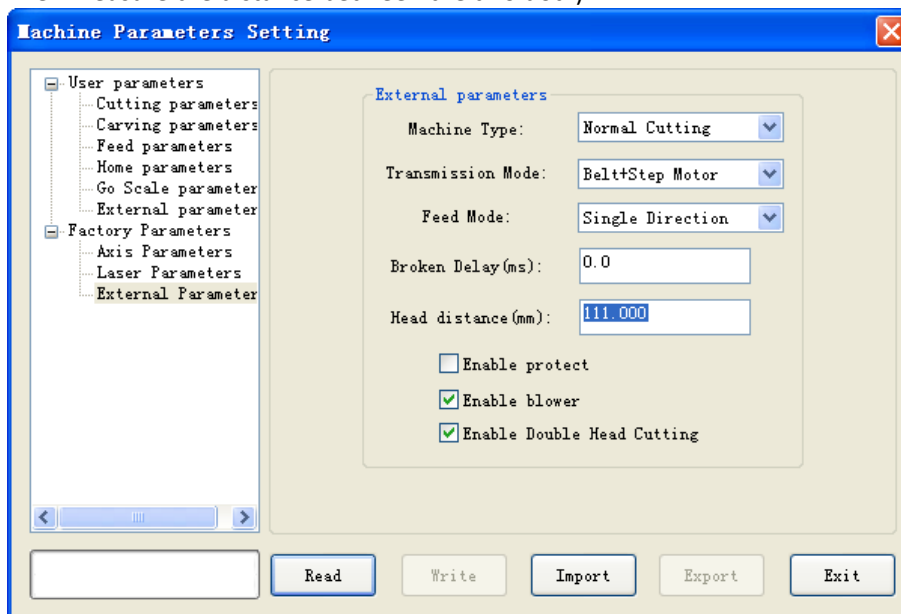

Fig 6-4

- 7) Select the “Home parameters” to choose the “Enable Z Home”.

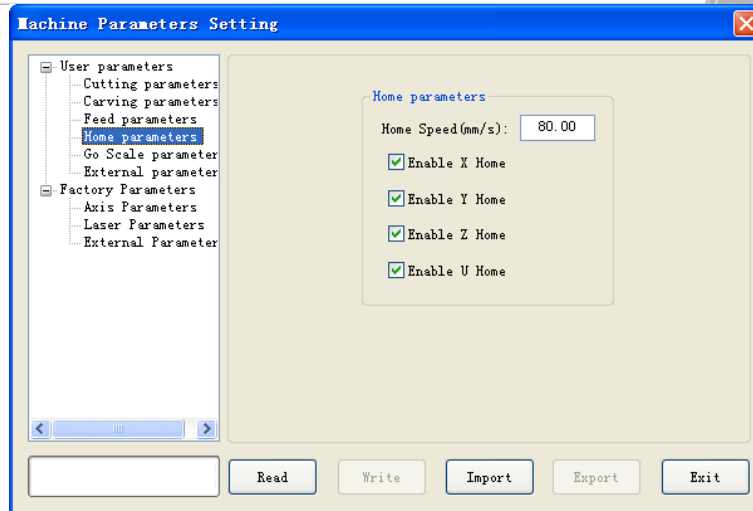

Fig 6-5

- 8) After finished the parameter setting then press the “Write” button to download the mainboard.
- 9) Because of the software can allow user to exchange the double-head and single-head mode, so user need to choose the option of “Electronic double laser head output” in the “Process” of the “Control Panel” in the software. Please refer to the Chapter3.4.2.





Chapter7 Applications

7.1 The method to connect mainboard

At first, please exchange the machine type of the software for the 5th controller. You can press the Menu “Tools” → “Machine” → “5th controller”.

Press the button of “USB Port: Auto” in the control panel.

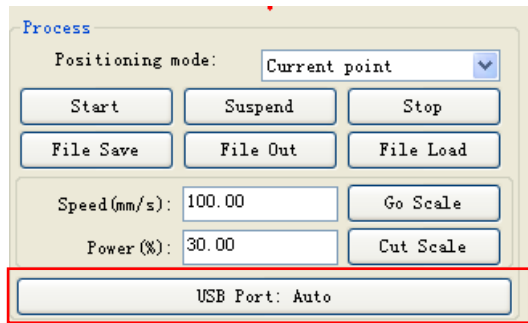

Fig 7-1

The below picture is the setting for the connection between PC and mainboard.

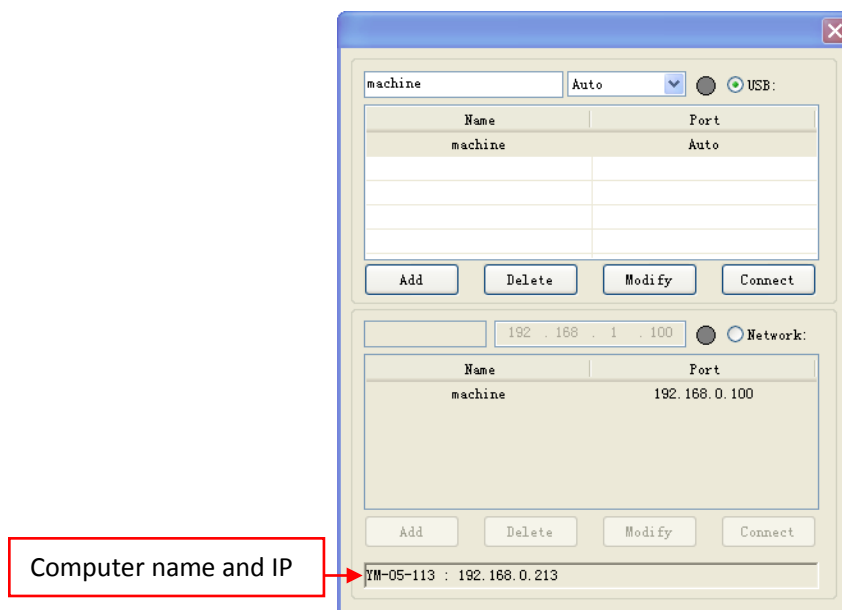

Fig 7-2

User can choose the connection between USB and Network mode.

Clicked “Connect” to test. It will shows “Valid port” if succeed, or else shows “invalid port”.

<p>Notes</p>	<p>The step of the IP setting of the network as example:</p> <ol style="list-style-type: none"> 1) The default IP of the mainboard is “192.168.1.100” 2) Set the Computer IP for “192.168.1.112”, but can’t allow to set the same as the machine IP. 3) Set the connection IP as “192.168.1.100”, if the connection can be used, then the LED button would be green.
---------------------	---





7.2 Machine Parameters Setting

Before you modifies the parameters of the machine, you must read the parameters from the machine at first. After you had modified the parameters, you need to press the write button to download the parameters to the machine.

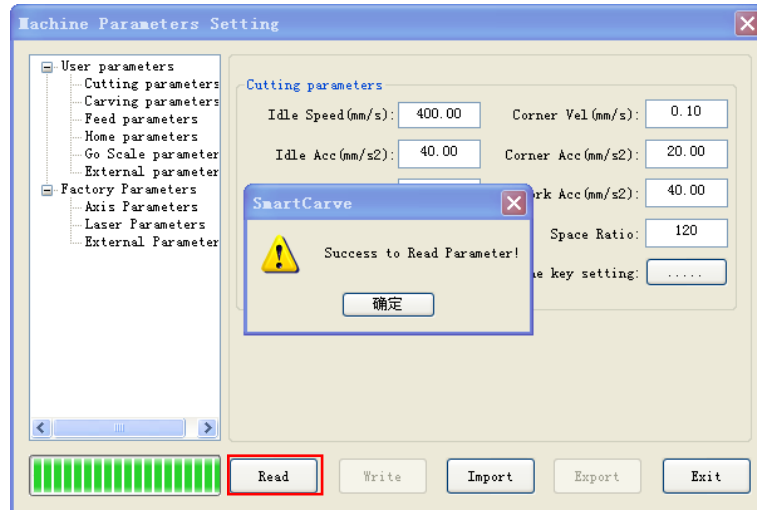

Fig 7-3 Read parameters

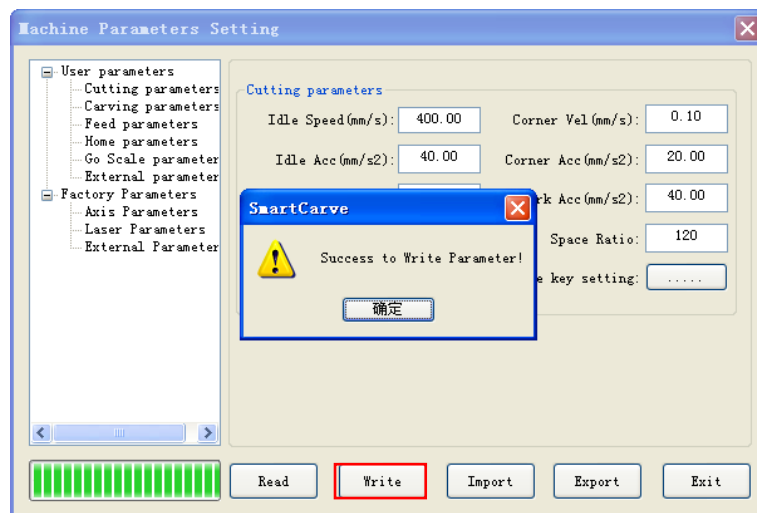

Fig 7-4 Write parameters

7.3 How to set the home parameters

Click the icon  to show [Machine setting]. Select [Home parameters], window is showed as below:



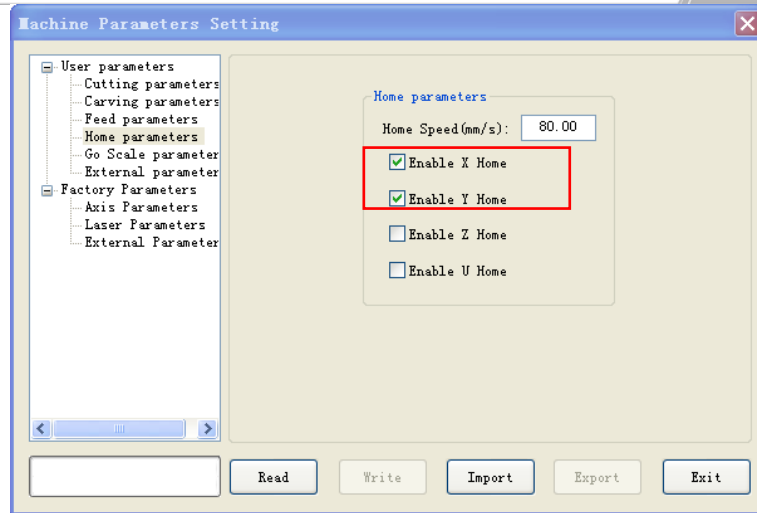

Fig 7-5

User can set the “Home Speed (mm/s)” of the XY axis and the home speed of axis Z and axis U is the 1.5 times jump-off speed. Also in this dialog, user can choose the axis which is enable to go home.

7.4 Breath

To set the breath based on the actual length and width of the machine. Measured from the machine origin, and the measurement should be smaller than the actual value of about 2mm.

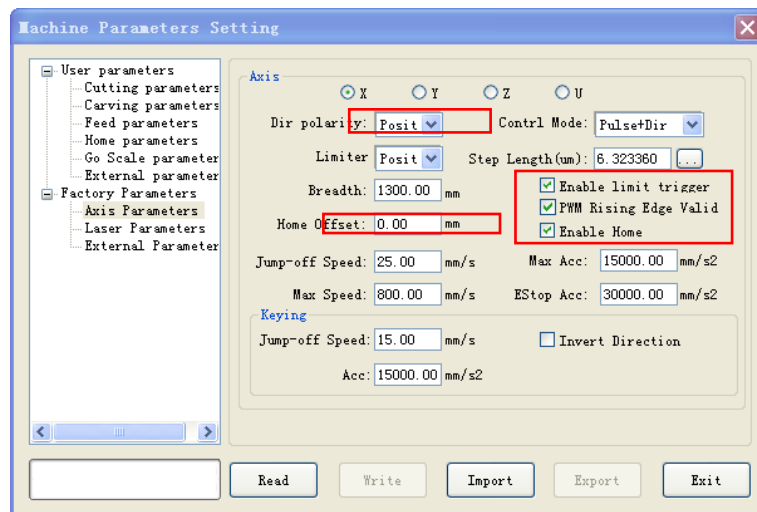

Fig 7-6

 Notes	<p>For the electric double-head laser machine, the breadth of the axis-X and axis-Z must be consistent.</p>
-----------	---



7.5 External parameters

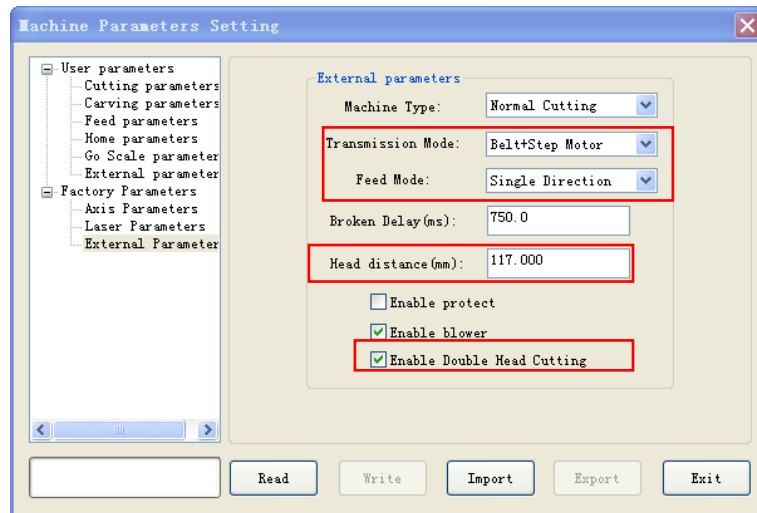

Fig 7-7



Notes

For the electric double-head laser machine, you need to measure the double head distance, the method to measure the two laser head distance is as below:

Let all axes to back to origin, press the pulse button on the control panel of the machine, and then measure the distance between two points of the two laser head.

7.6 Coordinates

7.6.1 Machine coordinates

Sometimes the machine's coordinate system may be inconsistent with the software settings, and need to re-set the software coordinates.

Click the menu "Tool" → "Settings" or click the icon  to enter the system setting dialog, and choose the option of "Workspace".

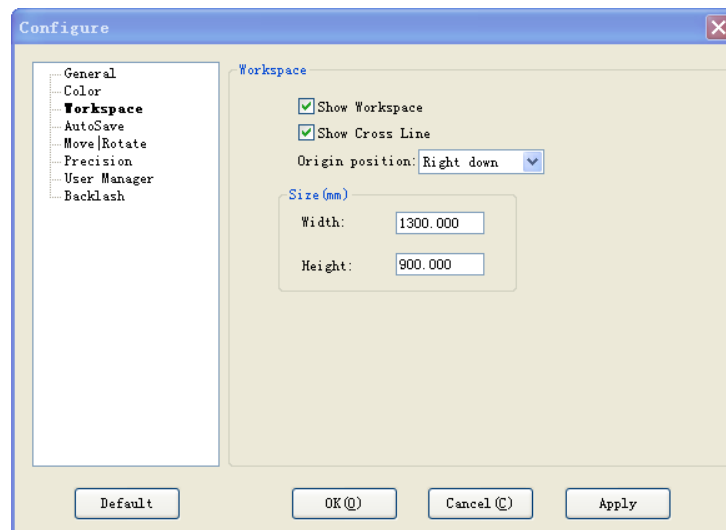

Fig 7-8





To choose the original position based on the actual machine coordinate system. There are four original position: Left up/Left down/Right up/Right down.

7.6.2 Relative coordinates

Right-click on the drawing area, select “coordinate” to show the dialog as below:

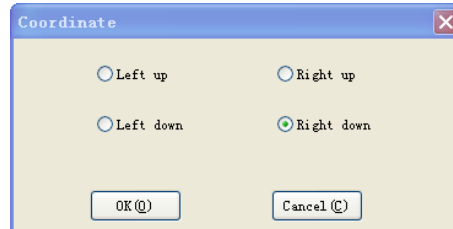

Fig 7-9

Choose the “Right down” option.

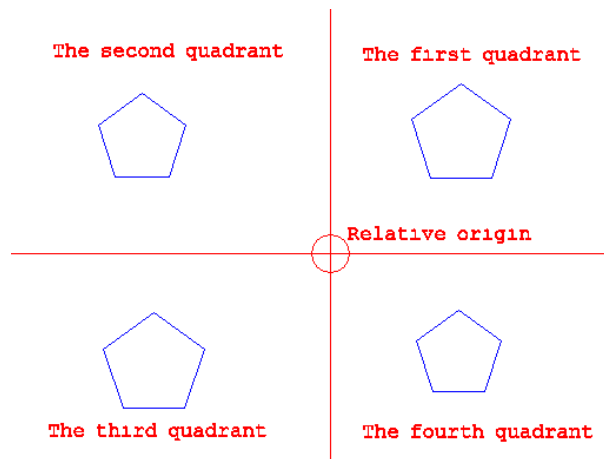

Fig 7-10





7.7 Normal processing

7.7.1 Vector graphics processing

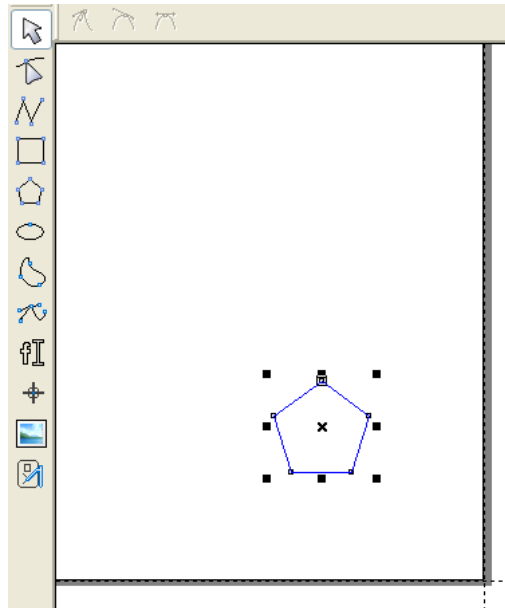

Fig 7-11

To move graphics by using arrange tools , for example moving graphics to origin by clicked the icon  ;

To set graphics size in the graph properties;

Right-clicked the working area to select “clone”, and setting dialog would be popup up. For example to set parameters as 3 rows and 3 cols.

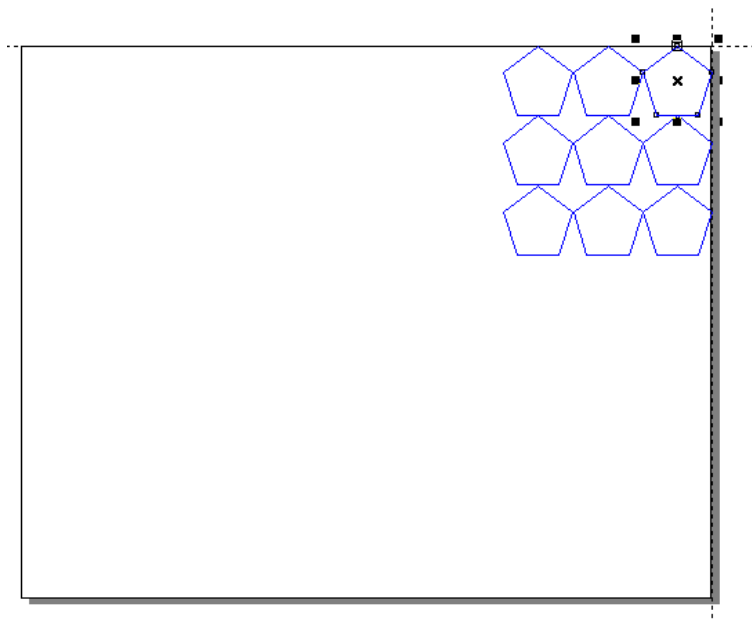

Fig 7-12





Before processing, you can download the file to the mainboard, and then click “Refresh” to get the file list , select the file , click “Calc time” to get the time needed for processing.

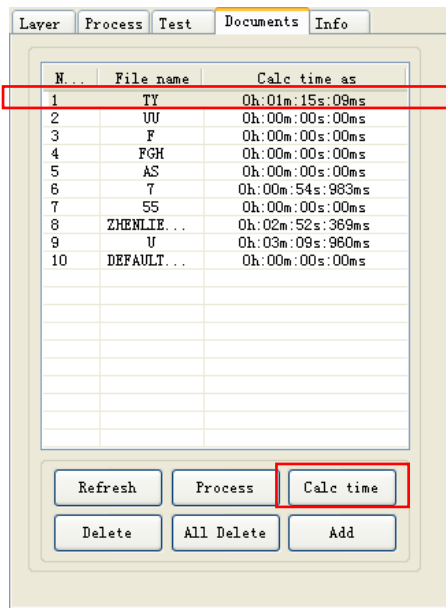

Fig 7-13

To get information about motherboard as below:

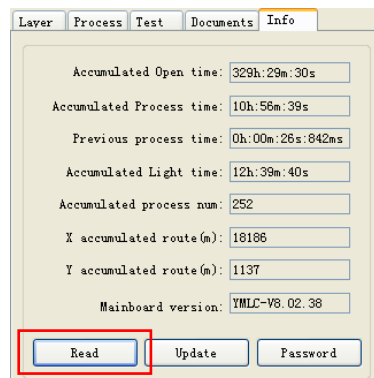

Fig 7-14

7.7.2 Bitmap processing

Click the icon  to import bitmap.



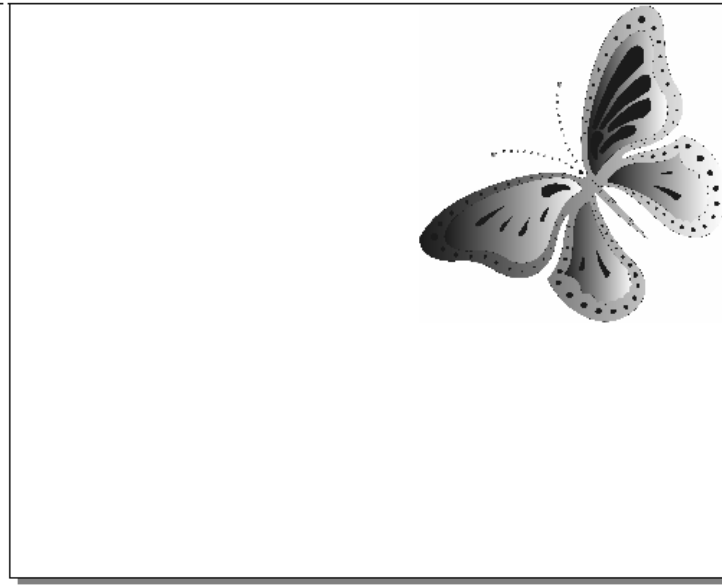

Fig 7-15 bitmap

User can modify the bitmap information in the property panel which shown as below:

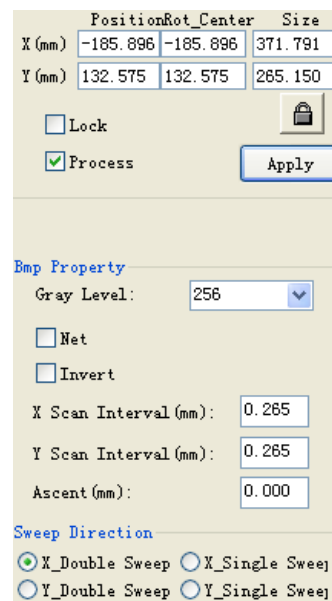

Fig 7-16

Clicked the “File Save” button to save the current data into a new processing file.

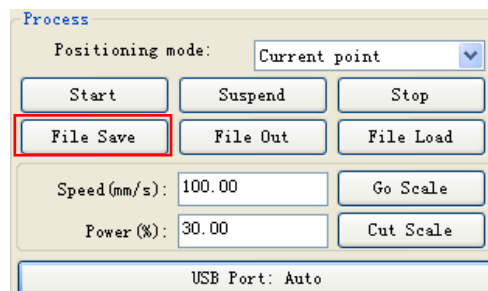



Fig 7-17



Clicked the “Start” button to download the data to the machine and start working.

7.8 Application of specific functions

7.8.1 Array function

Selected the graphics which need to convert to array. And clicked the icon  or right click the menu “Convert Array (A)” to popup up the array dialog:

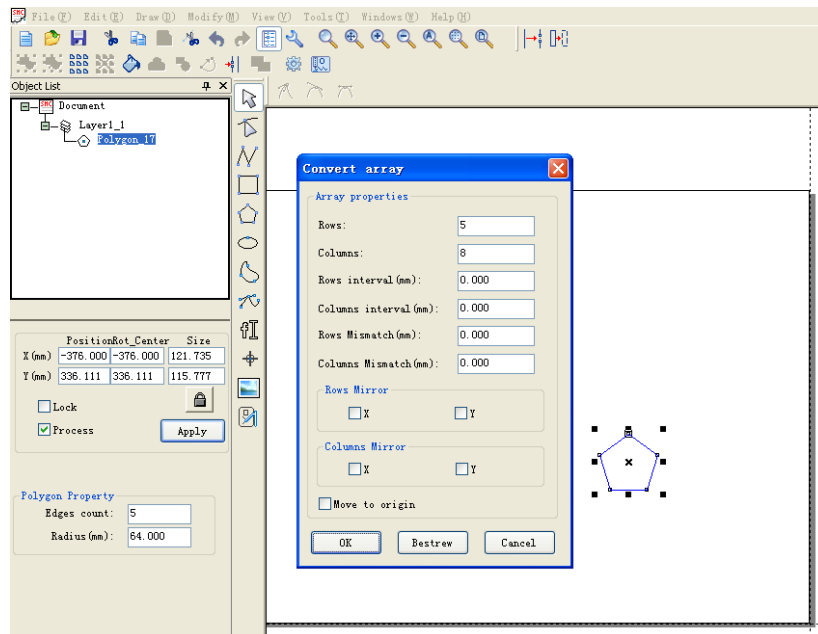

Fig 7-18 Array dialog

The properties of the array as below.

Rows/Columns: By defaults, according to the distance between the current position and the boundary to calculate the numbers of row and col. The Min is 1.

Rows interval/Columns interval: The default value is 0.

Rows mismatch/Columns mismatch: The default value is 0.

Rows mirror/Columns mirror: The graphics in the even- numbered lines will be mirrored.

Move to origin: the array graphics will be aligned to the origin.

Bestrew: According to the workspace length and width to calculate the numbers of row and col.

➤ Multiple arrays

To draw multiple arrays, show as below:



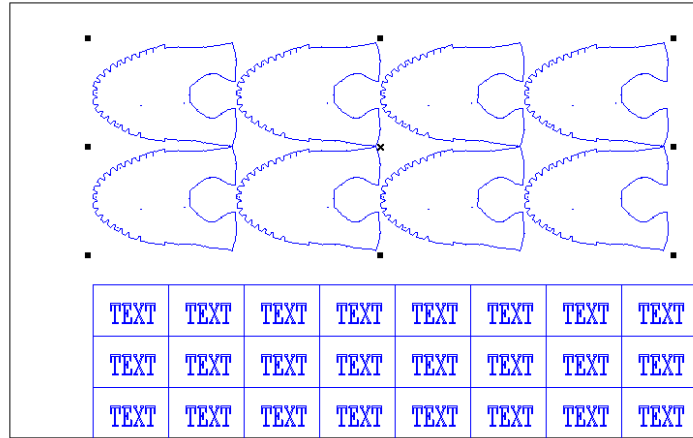

Fig 7-19 multiple arrays

Array graphics supports the following operations: move, rotate, mirror, size, shear.

 Notes	If selected the “feed line by line” option in the double-head laser machine, then the software can only process one array graphic.
-----------	--

7.8.2 About the leftover graphics outputting

Begin with the release version of “Smartcarve4.3.19” , 5th control will support multiple arrays, and the function of “convert leftover” is not used at the same time. The new method of outputting “leftover graphics” is more convenient. Do not use “convert leftover” every time; just output the data as its original shape. All the graphics, for example the array graphics and non-array graphics will be outputted.

Now we can output an array graphics and several other non-array graphics. First, we draw a graphics which will be converted to array.

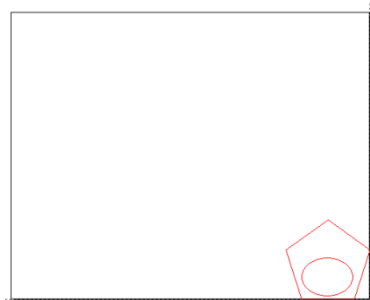

Fig 7-20 The original graphics of array

Then we convert it to be an array of 3 row 4 col;



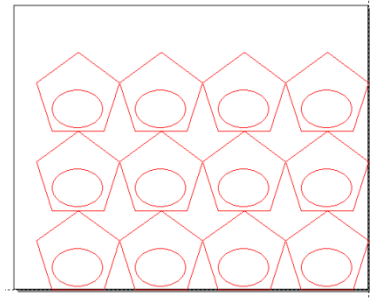

Fig 7-21 Array graphics

Draw or import several graphics, and the “convert leftover” is not used. The graphics can be drawn anywhere in the workspace.

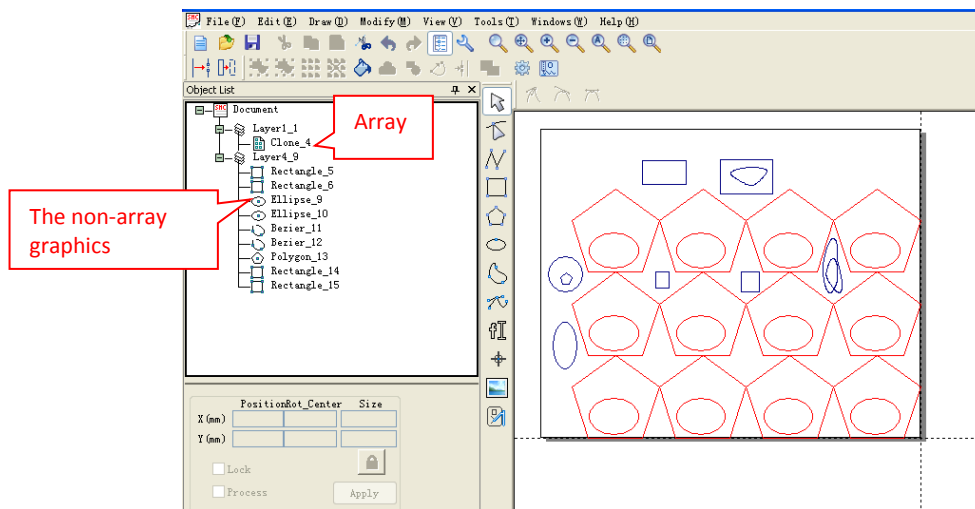

Fig 7-22

At last, click the button “start” to process. All the graphics is outputted.

7.8.3 Output graphics within the workspace range

➤ Processing time

In case that all the graphics are within the workspace range, for example show as below, arrange three array graphics and several other graphics, click “start” to download to the machine and start processing.

If the machine is electric double-head laser machine, system will automatically assign double head to process.



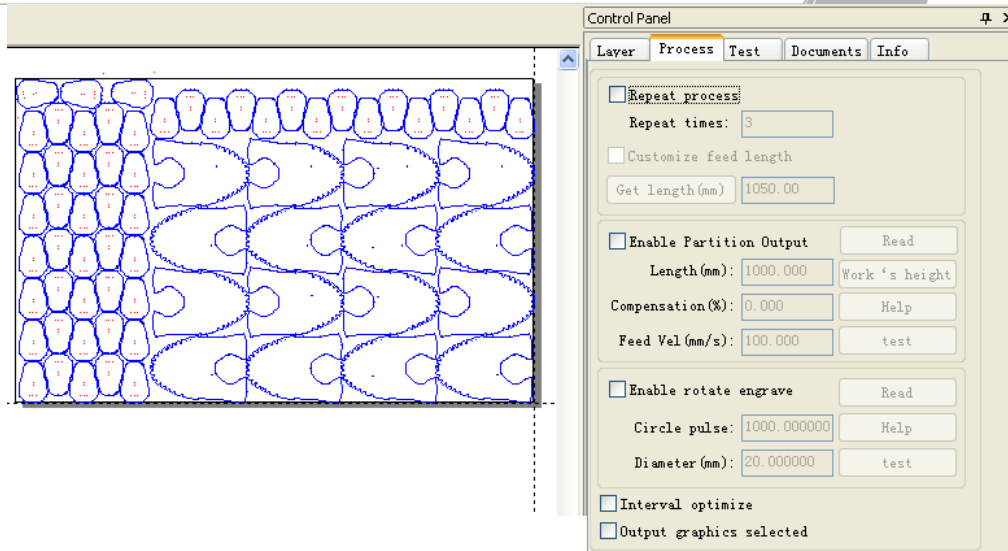

Fig 7-23 Non repeat process

➤ Repeat process

Repeat process three times, the system automatically calculates the feed length, shown as below:

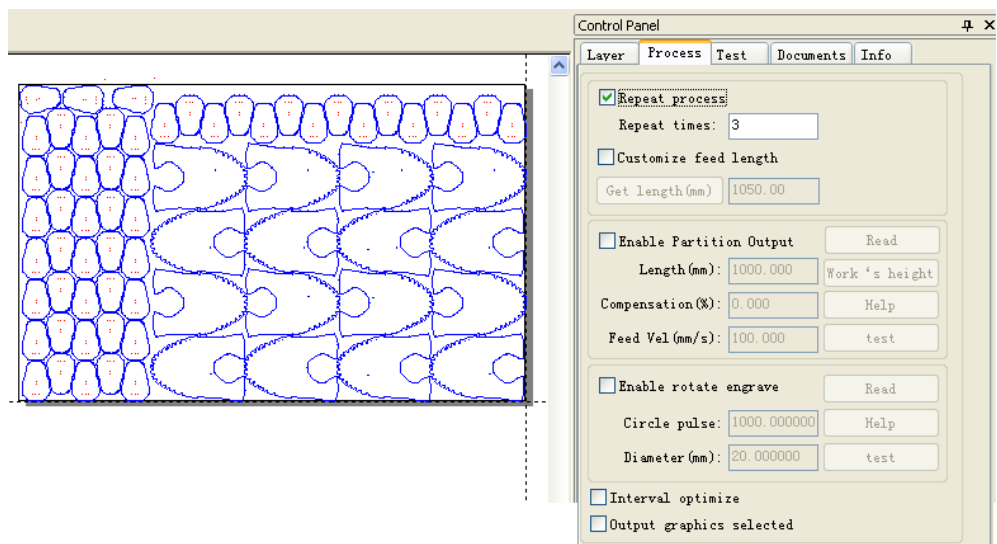



Fig 7-24 Repeat process

If the feed length is incorrect, you can select the option of “User define feed length” to customize the length.

7.8.4 Ultra-range graphics processing

7.8.4.1 Setting parameters

The function of normal processing only need to set a/b two steps, and the electric double-head laser machine need to set a/b/c/d four steps.

- a) To set the coordinate system, clicked the menu “Tools” → “Config” or clicked the icon  to show the configure dialog, then choose the “Workspace” option, select the origin position “Right down”, the setting is shown as below:

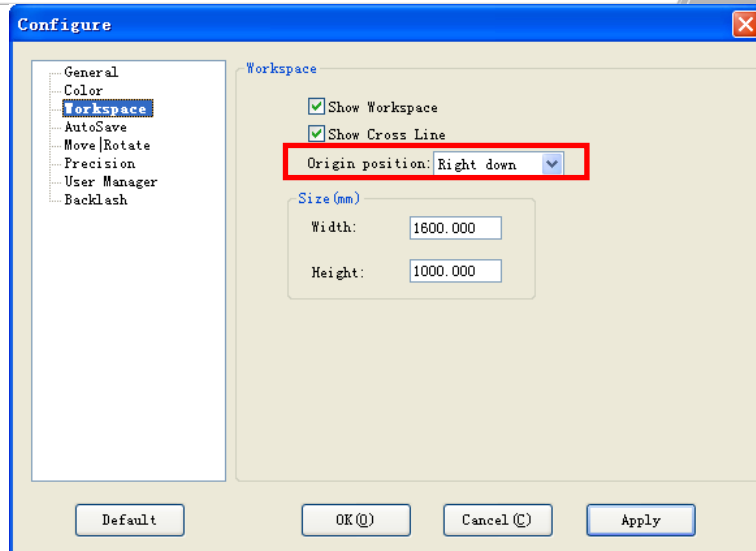

Fig 7-25

- b) To set the relative coordinate system, right-clicked the “Coordinate” option of the menu, selected “Right down” option in the dialog as below:

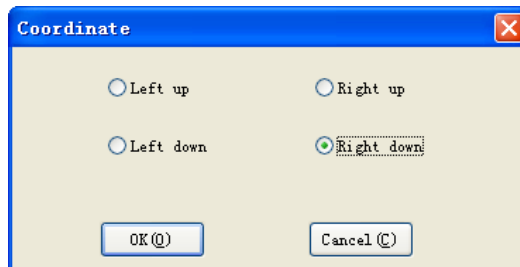

Fig 7-26

- c) Selected the menu “Tools”→ “Machine setting” to show the machine parameters setting dialog. Choose the option “Axis parameters” of the “Factory Parameters” to enter the axis parameters dialog. Then user need to set the “Breadth” of the axis-x and axis-z, and the value must be set same in the double-head laser machine. Also the “Enable Home” option must be chose.

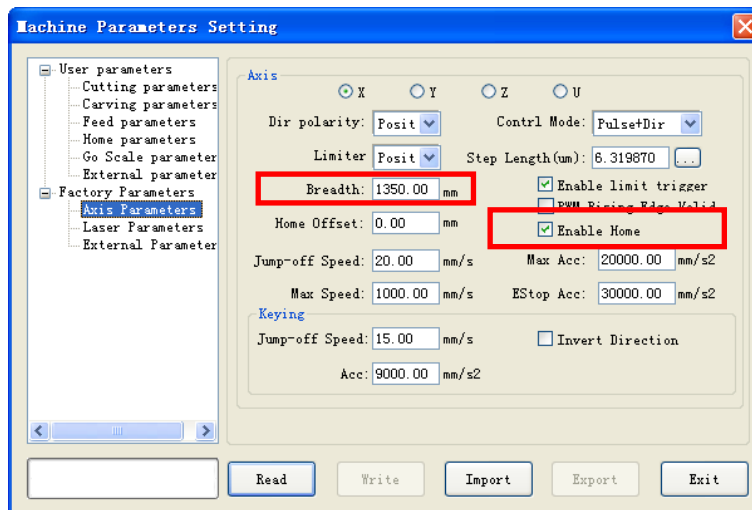

Fig 7-27 Axis-X

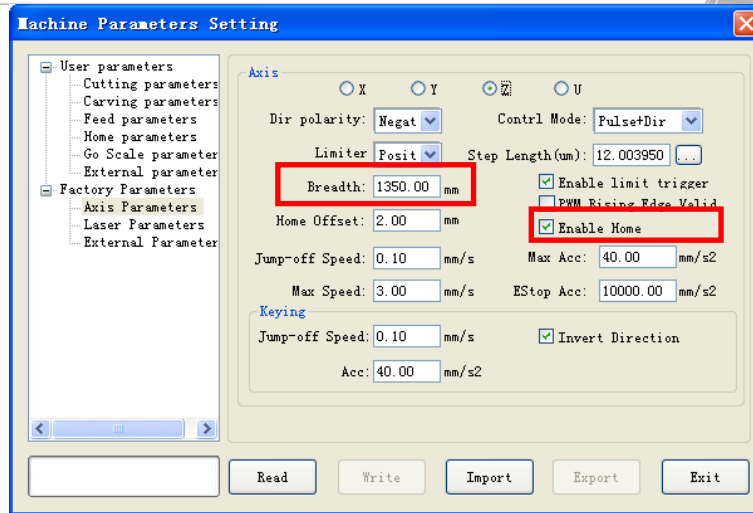

Fig 7-28 Axis-Z

Selected the option of “Home parameters” and chose the “Enable Z Home”.

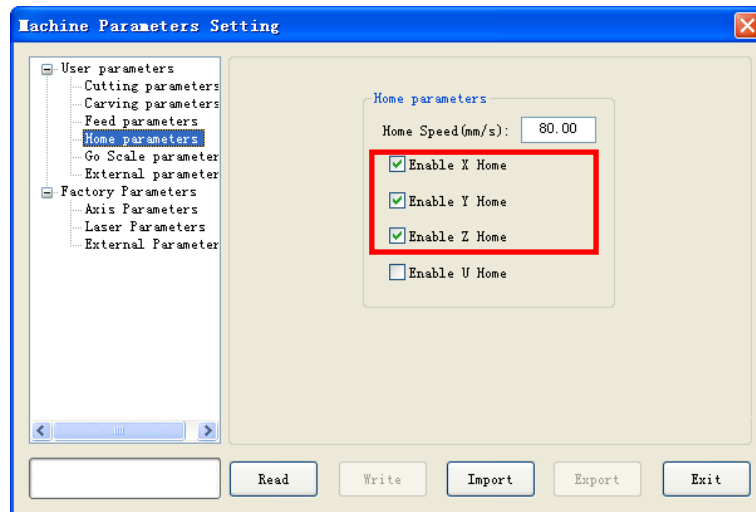



Fig 7-29

 Notes	<p>About the setting of the Breadth for the axis x and axis z:</p> <ul style="list-style-type: none"> ✧ The parameters “Breadth” of axis X and axis Z must be consistent. ✧ In actual commissioning, press the reset button on the control panel of the machine, after the axis had back to the home position, then move the axis-x to the maximum position until the signal is triggered, then get the current coordinate position from the machine’s control panel, the coordinate value minus about 2 mm is the “Breadth” of the axis-x and axis-z.
--	--

d) Selected the “External parameters” of the “Factory Parameters”.

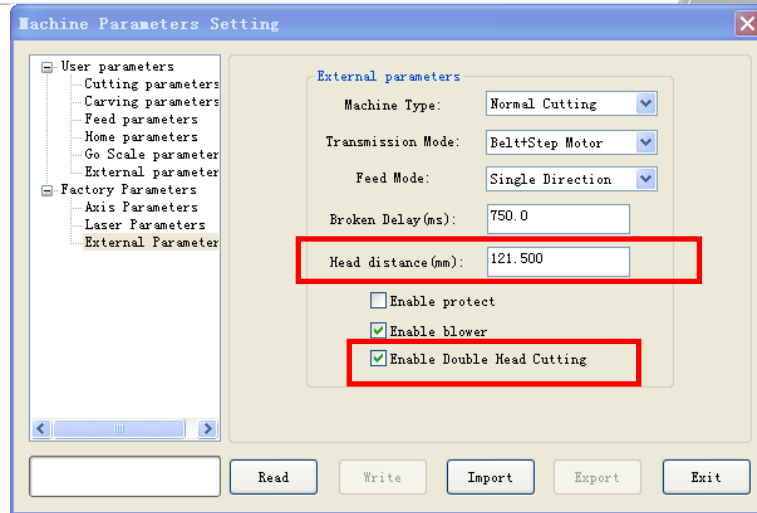

Fig 7-30

How to get the parameter “Head distance”?

Press the “reset” button of the control panel of the machine, after the axis had back to the home position and press the “pulse” button to open the laser, then measure the two dot distance of the two laser head.

7.8.4.1.1 Compensation setting

Refer to the chapter [3.4.2](#).

7.8.4.2 Ultra-range non array graphics processing

For example, the current workspace size of X is 500mm and Y is 300mm, but the graphics size x is 241mm and Y is 643mm.

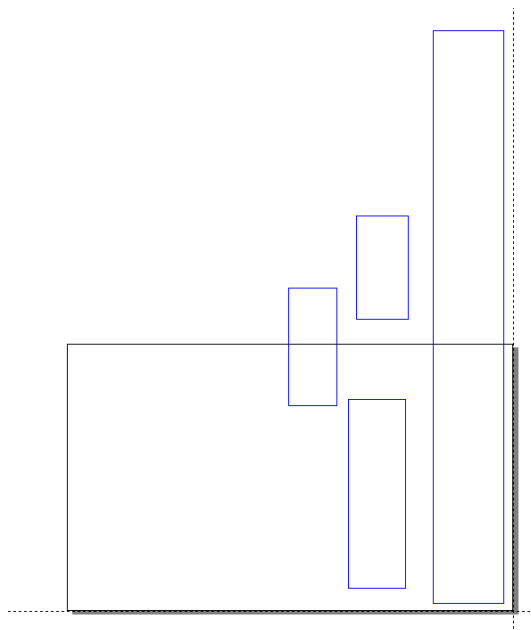
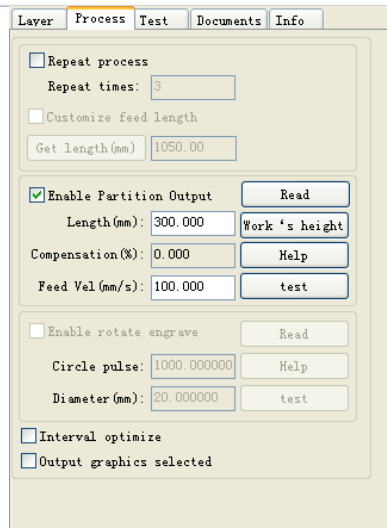

Fig 7-31 Ultra-range non array graphics

Selected the option “Enable Partition Output”.

**Fig 7-32**

According to the setting parameters of the above dialog, the graphics would be divided into three parts. The result is shown as below.

**Fig 7-33 The first****Fig 7-34 The second**



Fig 7-35 The third

7.8.4.3 Ultra-range array graphics processing

For example, the current workspace size of X is 1600mm and Y is 1000mm. There are three array graphics and several other graphics in the drawing area. Set the length of partition as 1000 mm, and move the axis to zero. After all, click “Start” button to processing. If there have the offset of the actual machine’s feeding, set “Compensation” to correct deviations.

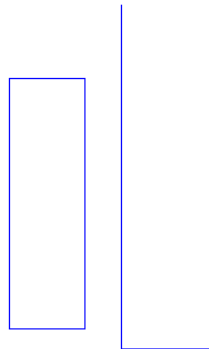
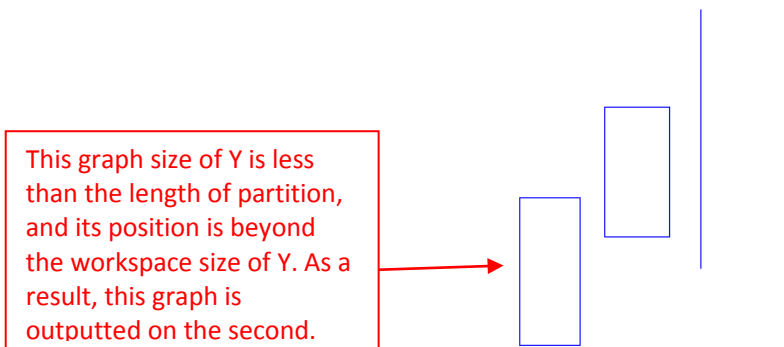
If the machine is electric double-head laser machine, system will automatically assign double head to process.

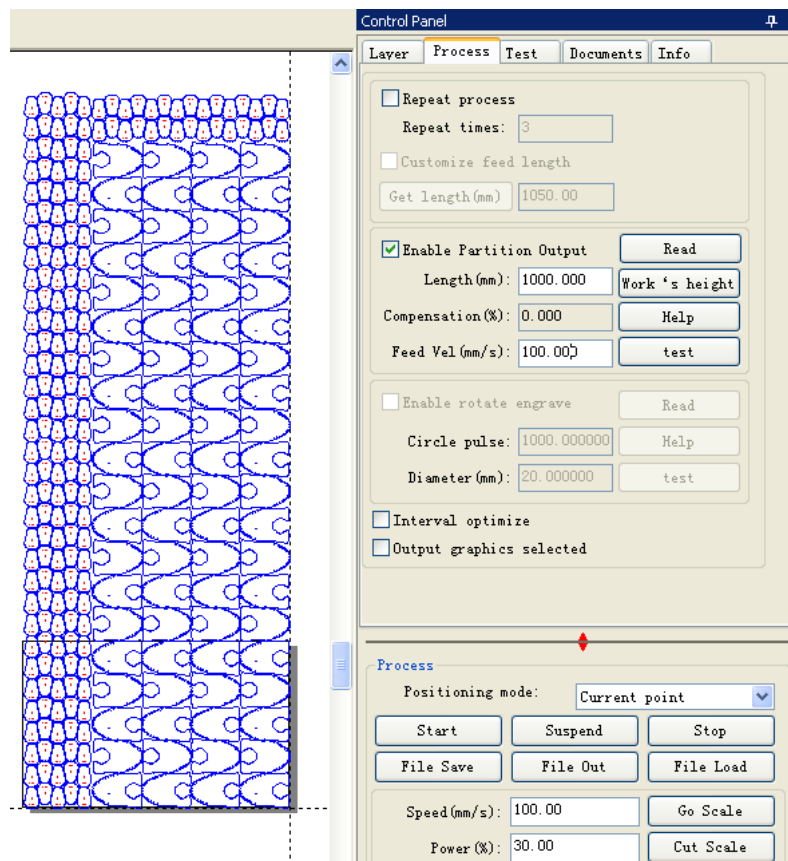

Fig 7-36 Ultra-range array graphics output

7.8.5 The operation of double-head laser machine

7.8.5.1 Setting parameters

Please refer to [7.3](#), [7.4](#).





7.8.5.2 Processing

Please refer to [7.8.1](#)、[7.8.2](#)、[7.8.3](#)、[7.8.4](#).

7.8.6 The operation of exchange platform

7.8.6.1 Setting parameters

On machines with the function of exchange platform to achieve repeated exchange, you need to set the following parameters:

Clicked the icon to show “Machine parameters setting” and selected “Factory parameters” → “External parameters” option.

Set the “Feed mode” as “Bi-direction”.

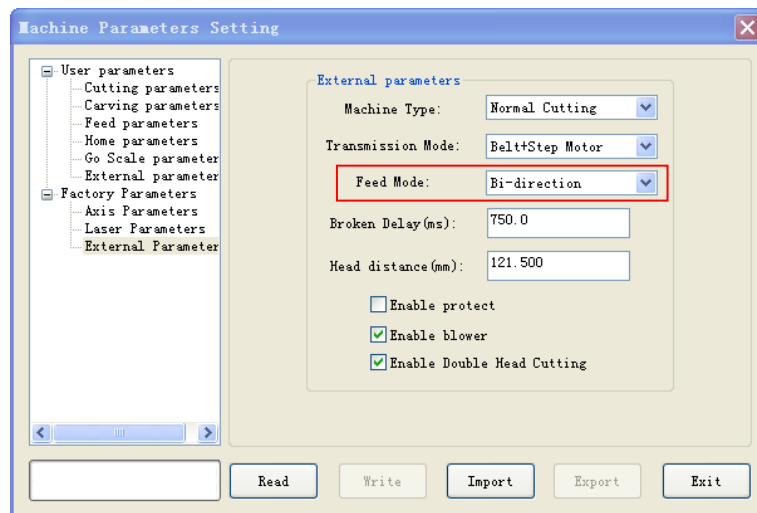

Fig 7-37

- Selected the “Feed parameters”, the delay parameters must be set according to the actual situation.

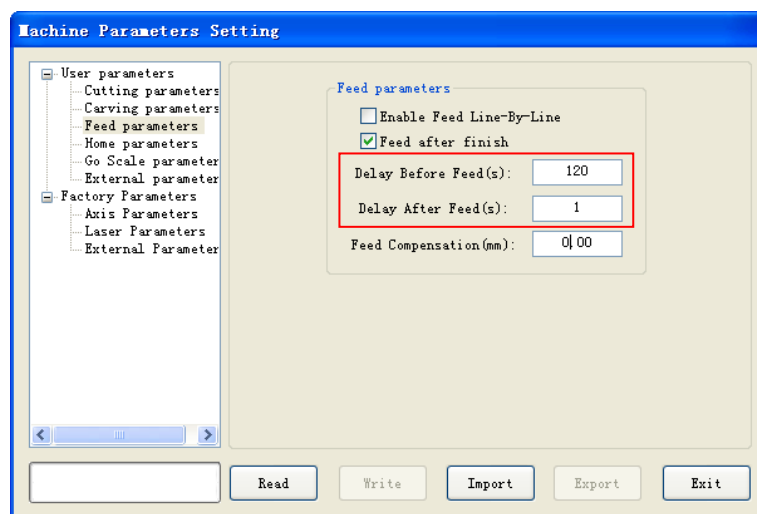

Fig 7-38

Delay before feed: sufficient time must be set to the loading and unloading material, the range is 0~300s.



Delay after feed: after switching platform, waiting for the platform to stabilize. The range is 0~300s

- The setting of the feeding length

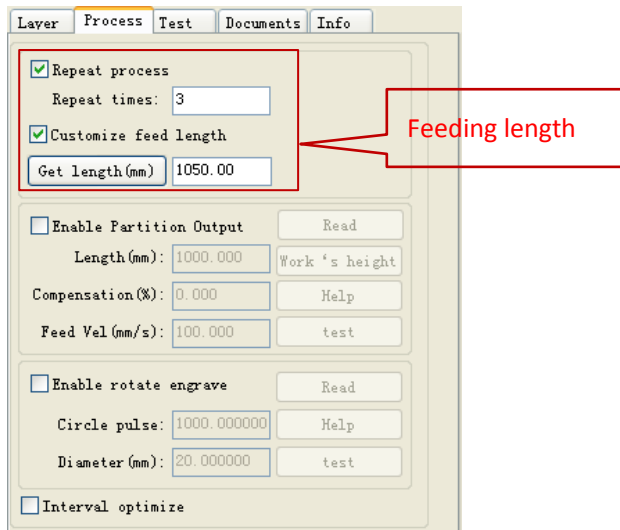

Fig 7-39 Feeding length

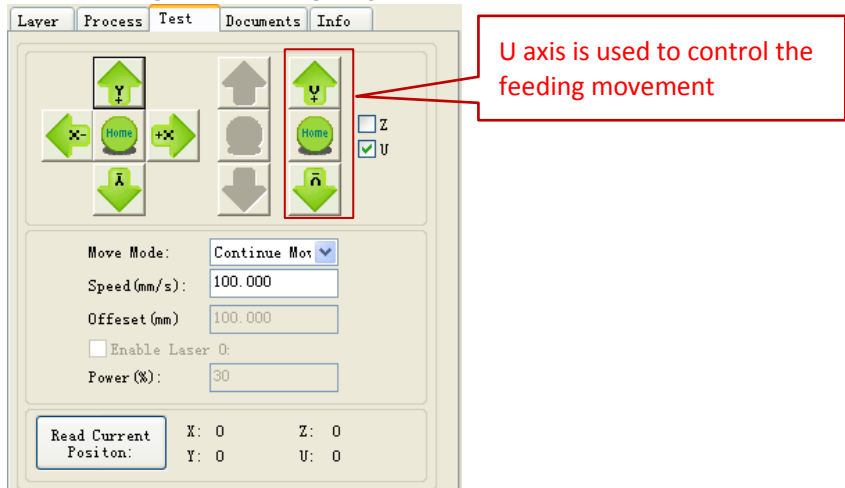

Fig 7-40

Set the Axis-U go to zero position and measure the feeding length(L) as below:

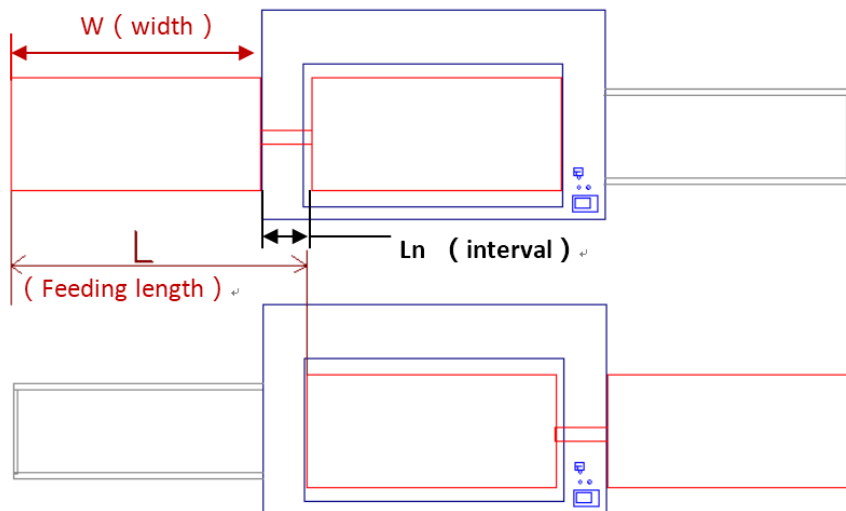



Fig 7-41 Feeding length

7.8.6.2 Processing

After above setting, import graphics to process. For example, the machine size is 1000mm width, and the distance between the two platforms is 50mm, it is need to switch 3 times platform. As a result, the feed length is 1050mm. To customize the feed length is shown as below:

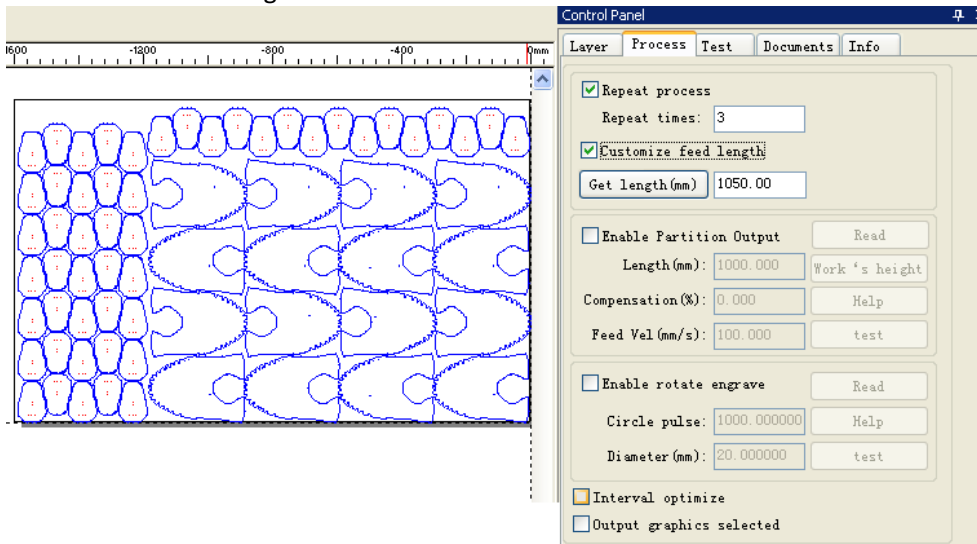



Fig 7-42

After all, click “start” to process.

7.8.7 Auto focus

On machines with the function of auto focus, you need to set the following parameters.

Click the icon  to show “Machine parameters setting” and choose “Factory parameters” → “Axis parameters” to enter the dialog of the axis parameters.

At first, click “Read” button to get the parameters of the mainboard, and click the “Write” button to download the parameters of the mainboard after modified.

Choose the axis z and set the “Home offset” to be zero.

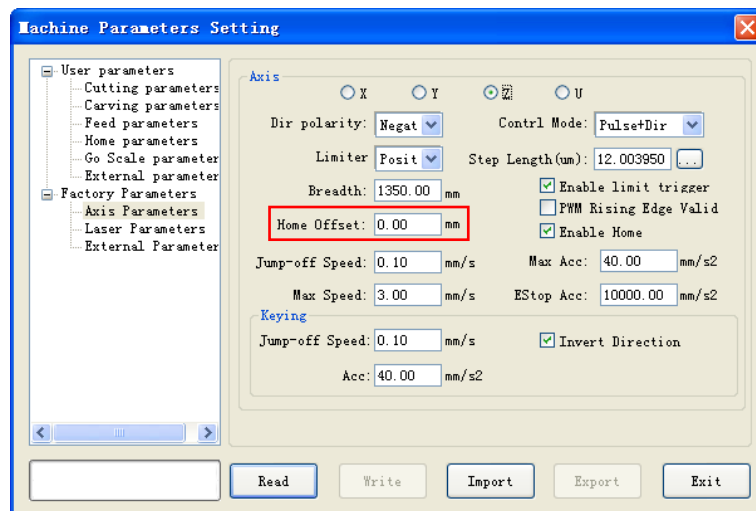



Fig 7-43

- Select “User parameters” → “External parameters” to set the focal length parameter as below:

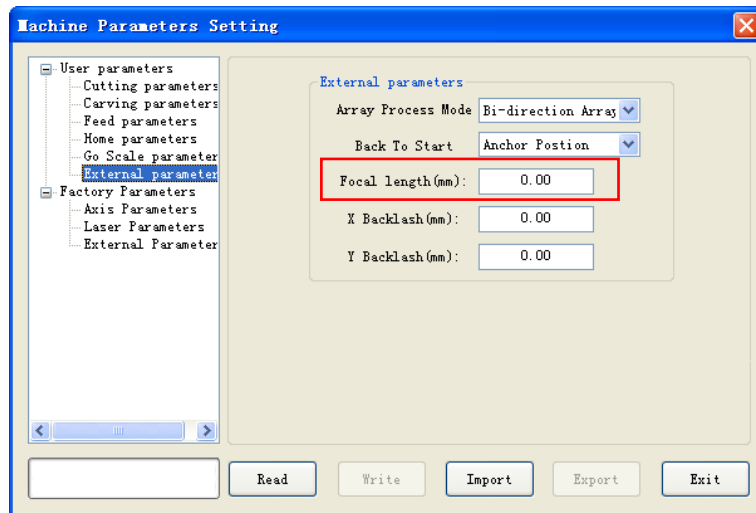

Fig 7-44

- After reset the axis-z, and select the function of auto focus on the machine panel, then the platform will be find the focus automatically.

7.8.8 The operation of the rotary engraving

In the 5th controller of our rotary engraving machine, the axis-Y is the rotation axis. After debugging the parameter “Circle pulse”, if the diameter does not change, you do not need to test again.

7.8.8.1 Setting parameters

- The method to test the pulse of the rotary axis

At first, enter the parameters “Diameter” and an arbitrary value to “Circle pulse”, for example: set the “Circle pulse” as 1000.

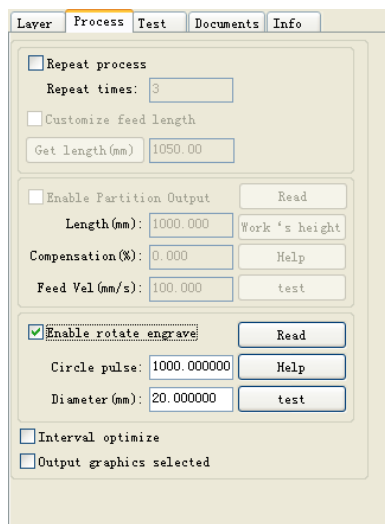

Fig 7-45

Click the button “Pulse” on the machine panel to shot laser for getting the first point, and then click the button “Test” of the software to make the axis-Y one rotation.





After all, click the button “Pulse” again to get the second laser point. If the two points at the same point, the “Circle pulse” is correct. If not, for example the actual length of movement is 62.5mm, click the button “Help” to set parameter, the dialog is shown as below:

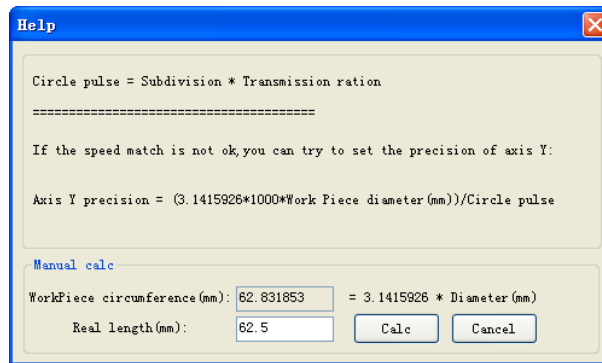
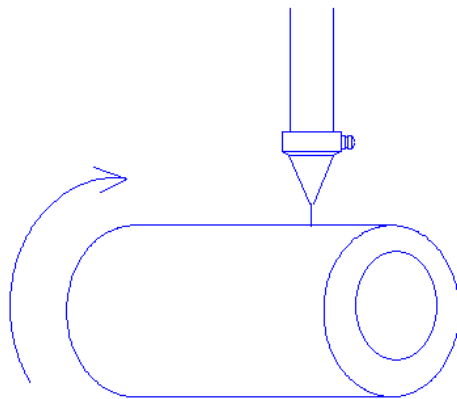

Fig 7-46 Calculate circle pulse

And then click the button “Calc” to calculate circle pulse. Repeat the above steps again until you get the two points coincide.



Get the first laser point at the beginning of the rotation.
Click “Test” button to rotate the Y-axis.
Get the second laser point.

Fig 7-47

Expand circumference, measure the distance between two points.

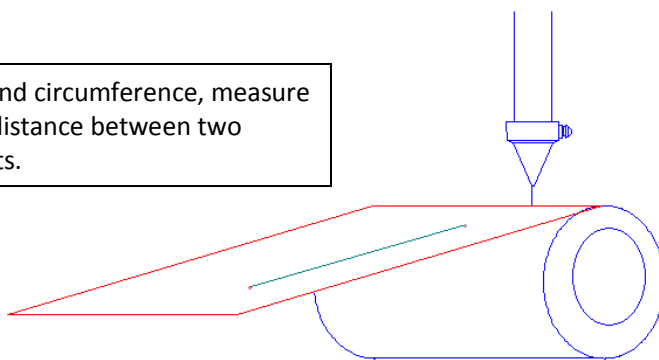

Fig 7-48



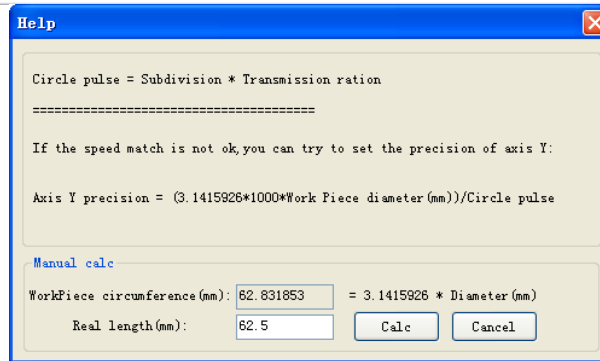

Fig 7-49

7.8.8.2 Processing

If the above parameters are set correctly, then you can select the option “Enable rotate engrave” and click “Start” button to processing.

7.8.9 Graphic counting mode

7.8.9.1 Changes in interface

- (1) The “Enable graphic counting mode” option is added to the “Process” tab of the software control panel.

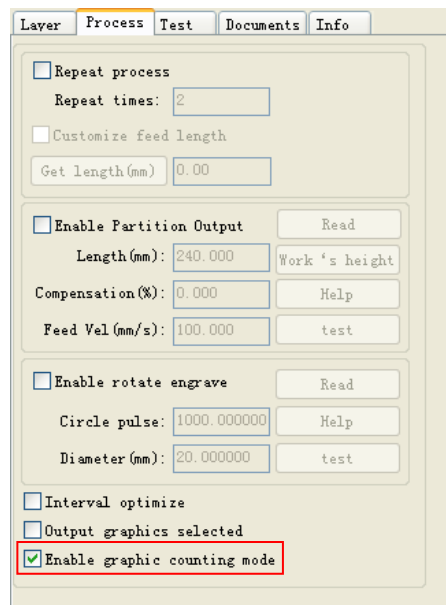

Fig 7-50

- (2) A list showing selected entity information is added to the Documents tab.

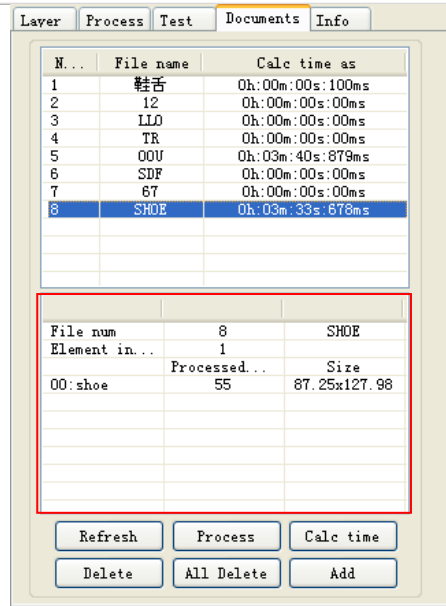

Fig 7-51

7.8.9.2 Function configuration and limitations

(1) Configuration environment of new functions

The mainboard program must be RDC-V8.02.41 or later to have new features;

HMI panel program must be HMI-V4.6.4 or later to display new features;

The versions of SmartCarve4.3 software with the option “Enable graphic counting mode” support new features;

The upgraded mainboard support the processing of .oud files in both new format and old oud format.

New file format: The .oud files generated by “Enable graphic counting mode” have graphic counting function;

Old file format: The .oud files not generated by “Enable graphic counting mode” or generated by early versions of SmartCarve4.3 software do not have automatic counting function.

(2) Limitation 1 of new functions

- Due to mainboard memory constraints, up to 10 separate entities or groups can be output with “Enable graphic counting mode” function, as follows:

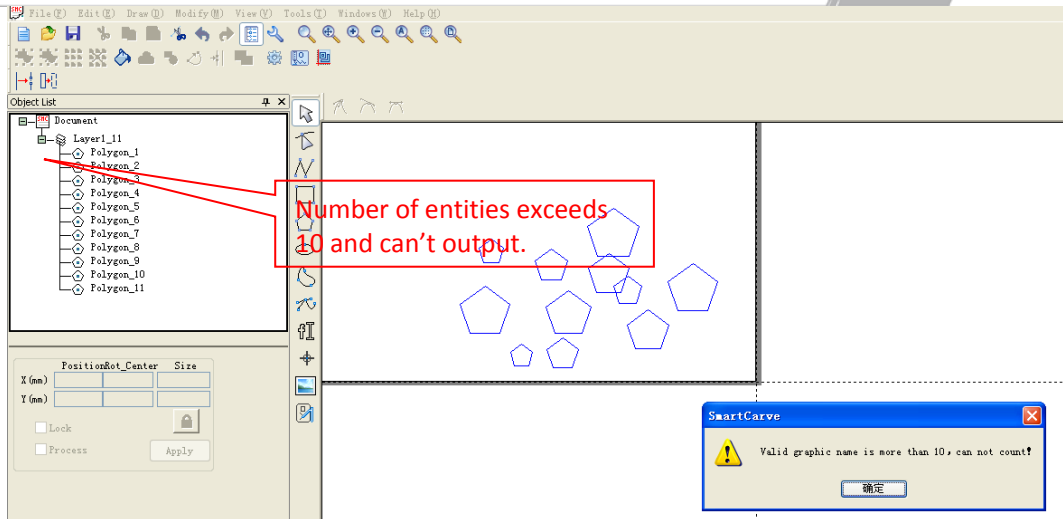
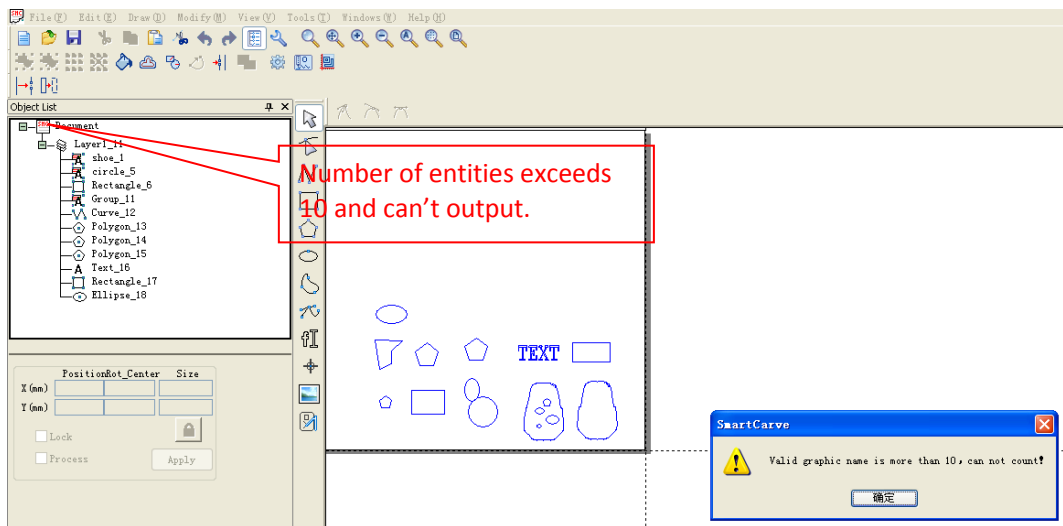
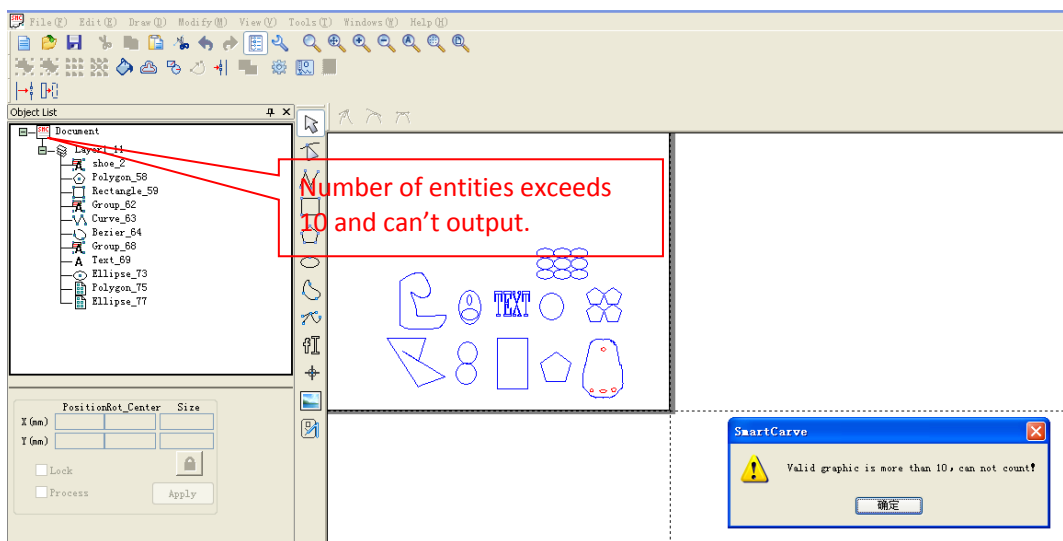
**Fig 7-52 Separate Entity****Fig 7-53 Entity Group and Separate Entity****Fig 7-54 Entity Group, Separate Entity and Array**

➤ **Counted entities**



Separate entities: rectangle, curve, polygon, ellipse, text, etc., each separate entity is counted by 1;

For entity group, each separate group is counted by 1;

For array entities, each separate array is counted by 1;

The counting can't be output if the total number of entities exceeds 10.

(3) Limitation 2 of new functions

Over-format processing and split output do not support graphic counting.

7.8.9.3 Process counting method

Within the same file, the mainboard distinguishes the entities by names, and the entities of the same name will be accumulated in the processing.

7.8.9.4 Output process data to the board

- (1) Import a process entity:

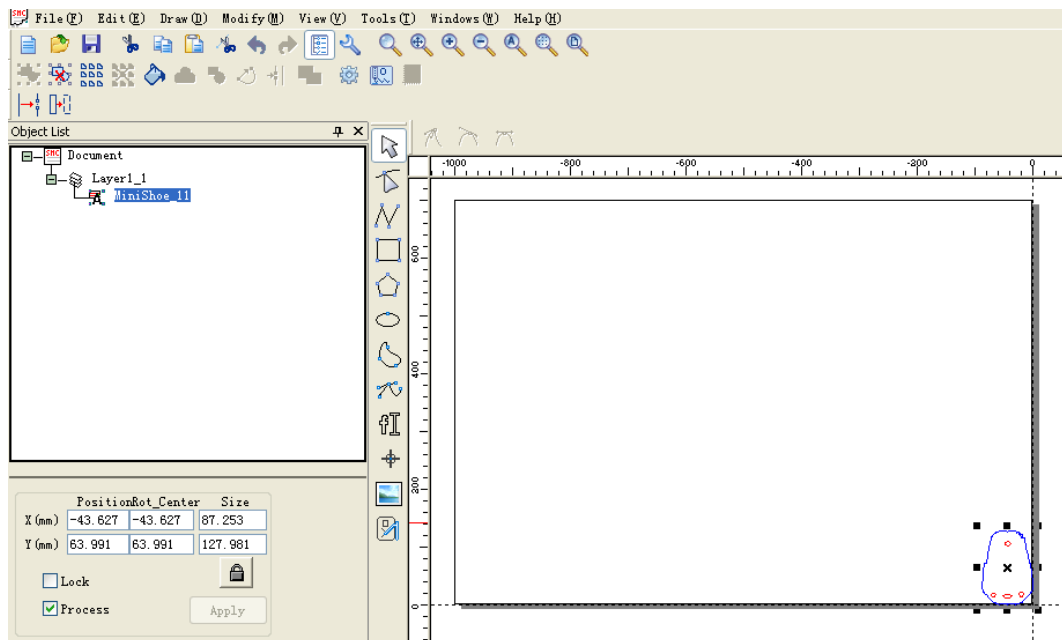

Fig 7-55 Original Graphic

- (2) Modify the name, which will be used to display the name of the mainboard graphics and distinguish count.



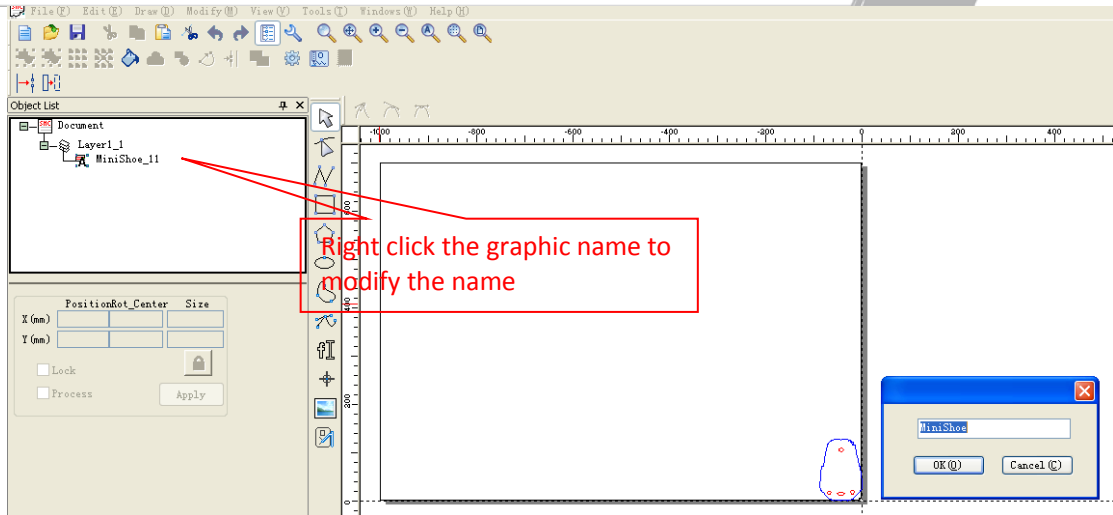

Fig 7-56 Modifying the Name

- (3) Generate an array and the default name of the generated array is the name of the entity.

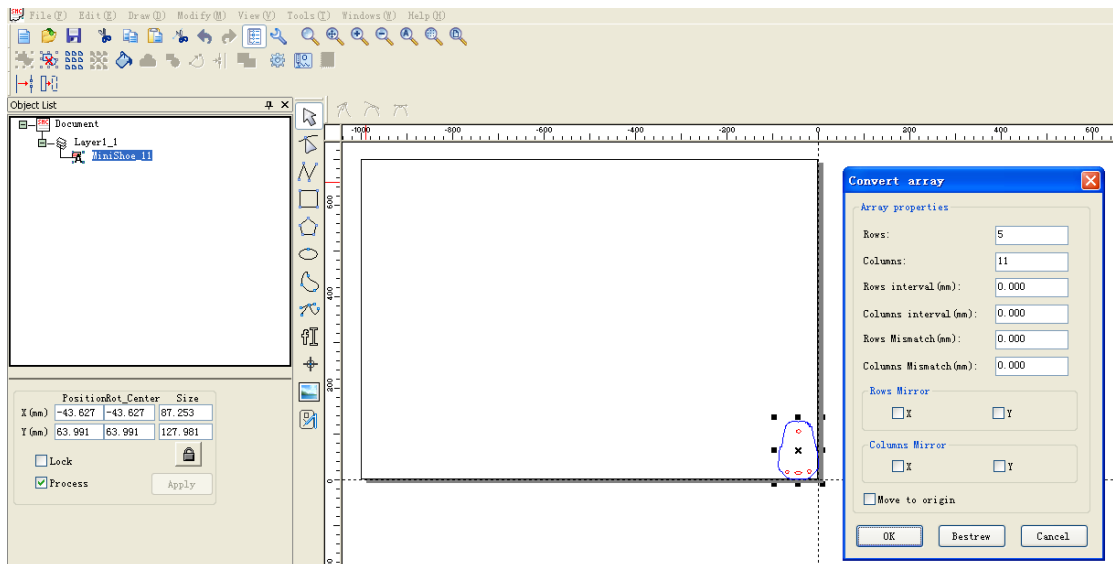

Fig 7-57 Generating Arrays

- (4) Modify the array layout information.

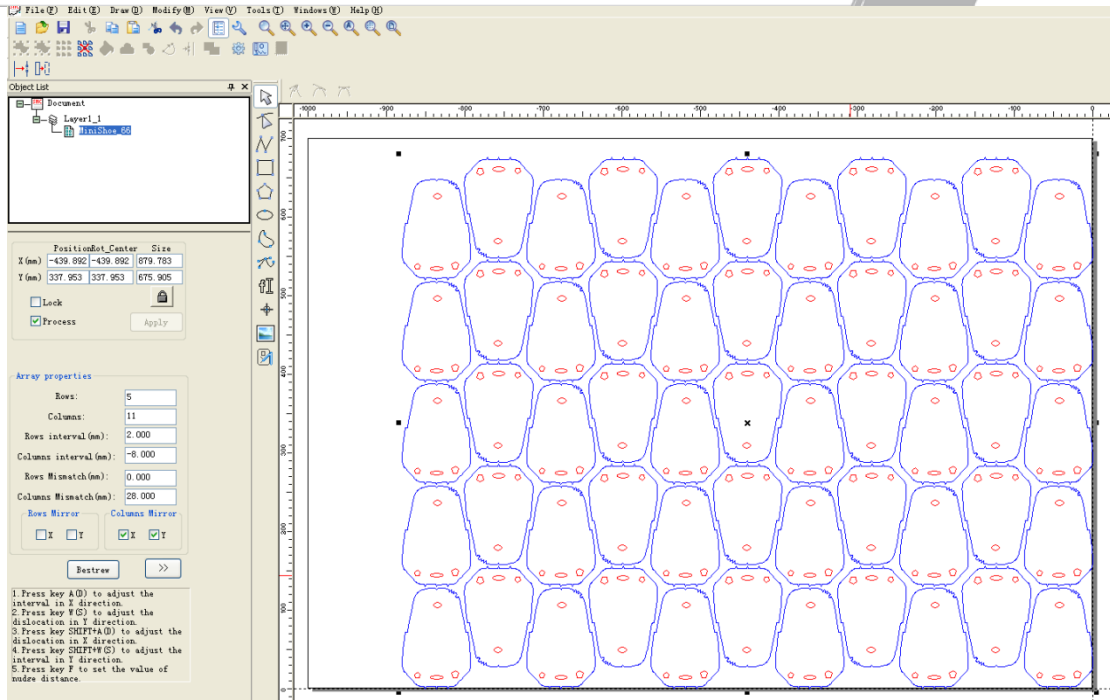

Fig 7-58 Modifying Array Information

- (5) Select the process output method, and whether repeat process



Fig 7-59 Enable counting mode but don't choose the repeat process mode

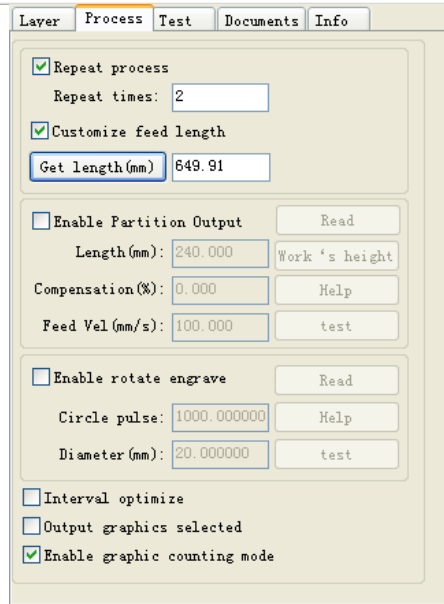

Fig 7-60 Enable counting mode and choose the repeat mode

- (6) Select “File Load” and save the data to the board

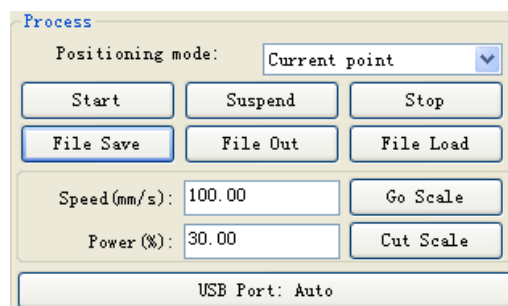

Fig 7-61

- (7) Enter the file name



Fig 7-62

- (8) Click the “OK” button to download the file to the mainboard, and then click the “start” button on the control panel to start processing.

7.8.10 Pen function

- 1) Set “Machine parameters setting” , Cancel the selection of “Enable blower”;

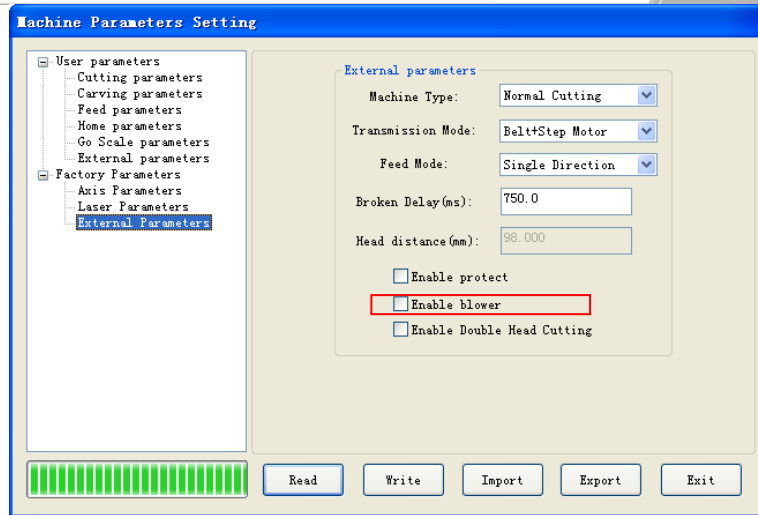

Fig 7-63

- 2) Refer to the board output IO is “5|Wind” ;

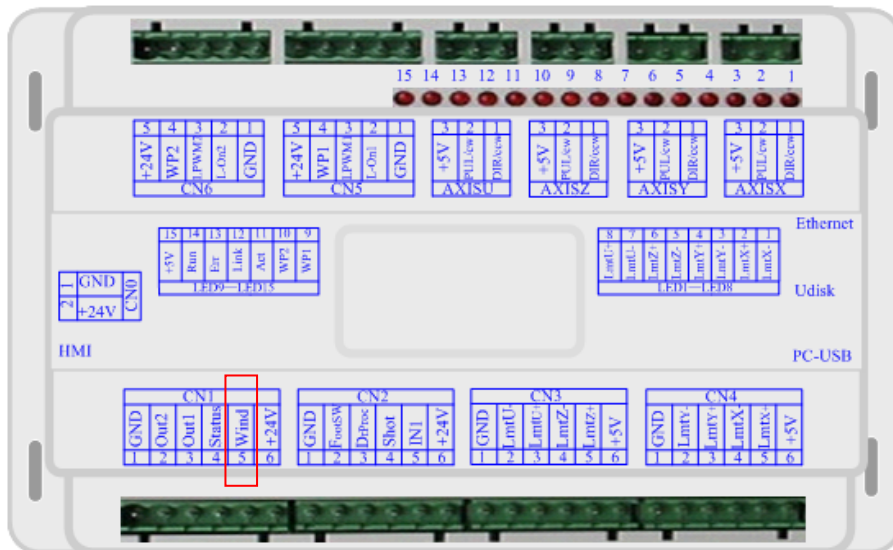

Fig 7-64 Pen function IO

- 3) On the software “control panel”, select “Pen offset” ;

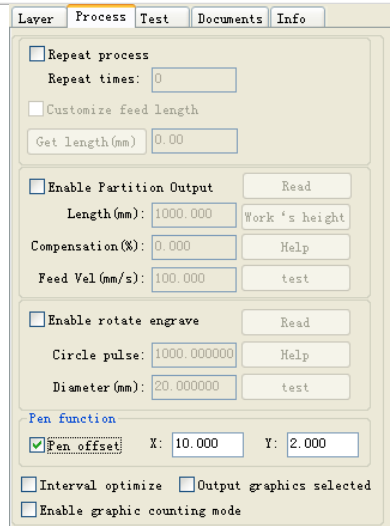

Fig 7-65

- 4) Set offset "X" 、 "Y" ;

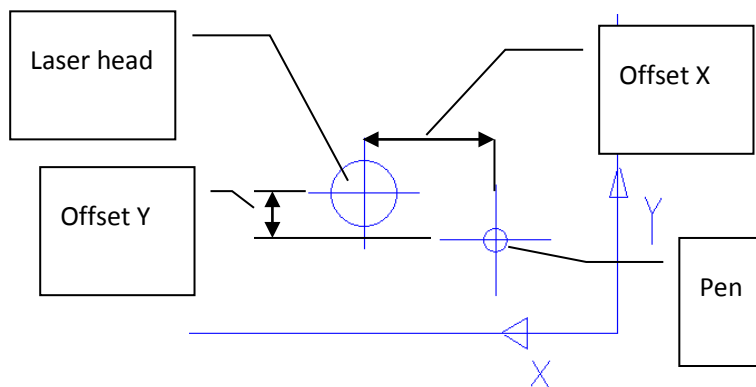

Fig 7-66

- 5) After set above, output data as usual. It will not output laser when processing, only pen draw.

7.8.11 History record

- 1) On the software "Documents" page of "control panel", Click "History";



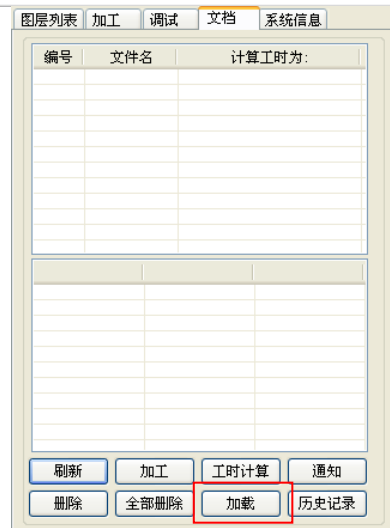

Fig 7-67

2) It will show "History record" dialog;

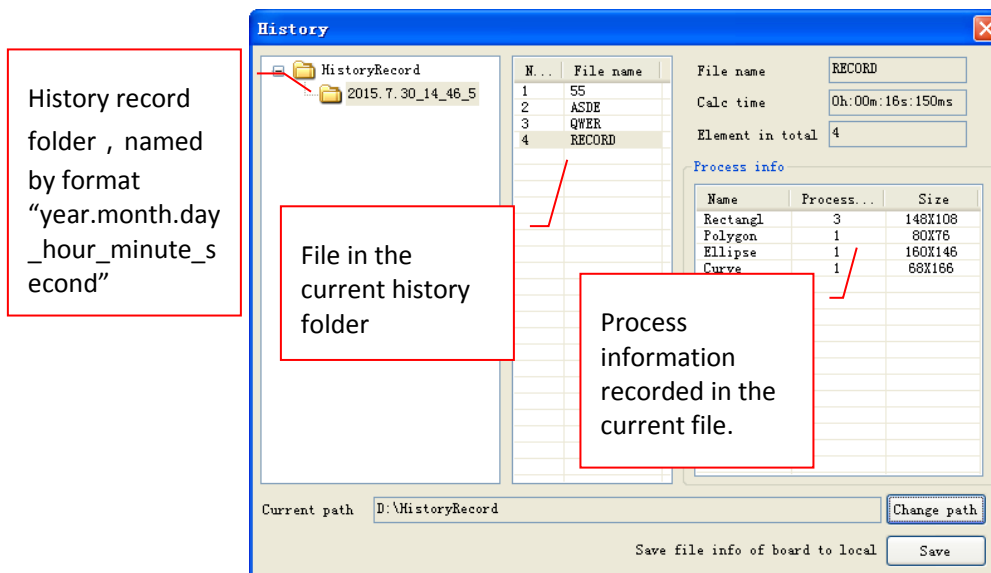

Fig 7-68

- 3) Click "change path" to select local path where to save;
- 4) Click "Save", A folder will be created automatically by software. And current file list of board will be recorded.



Post

All final right of interpretation of this manual belongs to GD HAN'S YUEMING LASER GROUP CO., LTD , we will do our utmost efforts to ensure the accuracy of the contents of this manual. We do not assume any responsibility caused by misspellings and typing errors. Your comments will be highly appreciated.



All rights reserved! Reprinting or copy without permission is prohibited. We reserve the right of lawing.

广东大族粤铭激光集团股份有限公司

地 址 : 东莞市松山湖高新技术产业开发区工业东路
28号

电 话 : 0769-89838888 89839999

传 真 : 0769-89833333

电子邮件 : yueming@ymlaser.com

网 址 : <http://www.ymlaser.com>

GD HAN'S YUEMING LASER Group Co., Ltd.

Addr : No.28 East Industrial Road,SongShan Lake
Hi-tech Industrial Development zone,Dongguan
City , Guangdong Province P.R.China

TEL.. : 0769-89838888 89839999

FAX. : 0769-89833333

E-mail : yueming@ymlaser.com

Web : <http://www.yueminglaser.com/>

